AHM PPI

Australian Health Management Plan for Pandemic Influenza



Australian Government
Department of Health

August 2019

Table of Amendments

Version	Amendments
April 2014	Original version
August 2019	• Administrative amendments—entire document
	• Attachment E, Menu of Actions—P1: Antivirals for treatment of cases
	• Attachment H, Evidence Compendium—new literature added

Australian Health Management Plan for Pandemic Influenza

Online ISBN: 978-1-74186-151-8

Publications approval number: 10776

Copyright Statement:

Internet sites

© Commonwealth of Australia 2019

This work is copyright. You may download, display, print and reproduce the whole or part of this work in unaltered form for your own personal use or, if you are part of an organisation, for internal use within your organisation, but only if you or your organisation do not use the reproduction for any commercial purpose and retain this copyright notice and all disclaimer notices as part of that reproduction. Apart from rights to use as permitted by the *Copyright Act 1968* or allowed by this copyright notice, all other rights are reserved and you are not allowed to reproduce the whole or any part of this work in any way (electronic or otherwise) without first being given the specific written permission from the Commonwealth to do so. Requests and inquiries concerning reproduction and rights are to be sent to the Communication Branch, Department of Health, GPO Box 9848, Canberra ACT 2601, or via e-mail to copyright@health.gov.au.

Acknowledgements

European Centre for Disease Prevention and Control (ECDC). Guide to public health measures to reduce the impact of influenza pandemics in Europe: 'The ECDC Menu' 2009. Stockholm, 2009, <https://ecdc.europa.eu/en/publications-data/guide-public-health-measures-reduce-impact-influenza-pandemics-europe-ecdc-menu>

The World Health Organization (WHO). Outbreak Communication, Best practices for communicating with the public during an outbreak. Report of the WHO Expert Consultation on Outbreak Communications held in Singapore, 21–23 September 2004. <https://apps.who.int/iris/handle/10665/69138>

National collaboration with state and territories and the health sector in development of the plan.

Ministerial foreword for the AHMPPI



The Australian Government is committed to keeping Australia secure against potential threats. The Government continues to fund initiatives such as the National Medical Stockpile, the World Health Organization Collaborating Centre for Influenza Research and Reference, and contracts for supply of pandemic vaccine to protect Australians.

However, it is inevitable that the world will face another influenza pandemic. While there is no certainty about where or when the next one will occur, Australia must be prepared. An influenza pandemic represents a significant risk to Australia. It has the potential to cause high levels of disease and death and disrupt our community socially and economically.

This plan—the Australian Health Management Plan for Pandemic Influenza (AHMPPI)—outlines Australia’s strategy to manage an influenza pandemic and minimise its impact on the health of Australians and our health system. The new and improved AHMPPI takes a significantly different approach

to the previous plan and outlines the measures that the health sector as a whole would consider taking in response to an influenza pandemic. Continuous and extensive consultation with states and territories and other relevant stakeholders has enabled feedback to shape the development of the document.

In 2009, the earlier revision of the AHMPPI was used to guide Australia’s response to the Influenza A (H1N1) pandemic. This latest version of the AHMPPI draws on lessons learned in 2009 and developments in the approach to pandemic response within the international community.

Key aspects of the new approach include:

- wherever possible, using existing systems and governance mechanisms, leveraging seasonal influenza response mechanisms to respond to a pandemic;
- applying a flexible approach, which can be scaled and varied to meet the needs at the time;
- making decisions based on available evidence;
- linking with emergency response arrangements;
- emphasising communication activities as a key tool in managing the response; and
- providing detailed guidance on collecting national surveillance data.

The AHMPPI will continue to be updated as new clinical evidence is developed. While there has been significant work in Australia to prepare for an influenza pandemic, we cannot afford to be complacent. This plan provides the guidance and a framework for leadership so we can make sure we are as prepared as possible to deal with an influenza pandemic.

A handwritten signature in blue ink, reading "Peter Dutton".

The Hon Peter Dutton MP
Minister for Health

Contents

How to use this document	6
PART 1	8
Overview of the National Approach	8
1 Executive Summary	8
2 Introduction	13
2.1 Aims of a national pandemic response.....	13
2.2 Key aspects of this plan.....	14
2.3 Comprehensive approach.....	14
2.4 Context of pandemic planning.....	16
2.5 Legal framework	16
2.6 Ethical framework	18
2.7 Proportionate response.....	18
2.8 Planning assumptions.....	23
2.9 Participating parties	23
2.10 Review and amendment	24
3 Escalation	25
3.1 Seasonal Influenza Arrangements.....	25
3.2 Escalation from existing arrangements.....	26
3.3 Escalation across stages	27
3.4 Activation of other plans	28
3.5 Enhanced arrangements.....	28
4 Governance.....	29
4.1 Roles and responsibilities	29
4.2 Decision making and consultation	34
5 Implementation	42
5.1 Prevention Activities.....	43
5.2 Preparedness Activities.....	43
5.3 Response Activities.....	44
5.4 Recovery Activities.....	51
5.5 Resilience.....	51
5.6 Emergence of the novel virus first in Australia	52
5.7 Application to seasonal influenza.....	53
6 Communications	54
6.1 Key Principles	55
6.2 Information gathering.....	55
6.3 Sharing information between those involved in managing the response	56
6.4 Public communications.....	59

PART 2	68
Operational Plan.....	68
PART 3	83
Support Documents.....	83
Attachment A. Glossary	83
Attachment B. Decision Making Committees	91
Attachment C. Communication materials	96
Attachment D. Decision Support Map	108
Attachment E. Introduction to the Menu of Actions Contents	116
Attachment F. Guide to Implementation	164
Attachment G. Surveillance Plan	170
Attachment H. Evidence Compendium	188
Attachment I. Governance Table.....	191

How to use this document

This plan is presented in three parts. Part one comprises the chapters of the Australian Health Management Plan for Pandemic Influenza (AHMPPI). Part two is the Operational Plan. Part three contains documents that provide additional detail to support decision making or operations.

The chapters of the AHMPPI provide a high level overview of the national approach to the management of an influenza pandemic in key areas. They are divided into:

Escalation:

An explanation of when arrangements under the AHMPPI will be used and how escalation through the stages will occur.

Governance:

An outline of the roles and responsibilities of key stakeholders and committees, and description of decision making and consultation processes.

Implementation:

An outline of the recommended overall approach to management of an influenza pandemic and discussion of the measures which could be implemented in each of the AHMPPI stages.

Communications:

A strategy for communicating with the public, the media and those involved in implementing the pandemic response.

The Operational Plan provides an operational checklist for planners (for use prior to or during a pandemic) of activities that could be considered for implementation in each of the AHMPPI stages. The Operational Plan is closely linked with the Implementation chapter.

The support documents are divided into:

Attachment A: Glossary

An explanation of terms and acronyms; acknowledgements and details of key committees.

Attachment B: Decision making committees

A description of the key government, health sector, health advisory and consultative committees involved in influenza pandemic decision making.

Attachment C: Communications materials

A template to support high level decision makers (such as AHPPC) in the development of consistent, comprehensive messages, and a table exploring methods of sharing information with the public, the media and those involved in implementing the pandemic response. Supports the Communications chapter.

Attachment D: Decision Support Map

A map, for high level decision makers (such as AHPPC) and planners, of the key decisions to be made in each stage of the AHMPPI. Includes general background and triggers for each decision.

Attachment E: Menu of Actions

A list of the public health measures that could be implemented during a pandemic and the key factors relevant to determining suitability for implementation.

Attachment F: Guide to Implementation

A quick reference tool for decision makers, showing which measures from the Menu of Actions are relevant to each stage of the AHMPPI.

Attachment G: Surveillance Plan

A guide to national surveillance activities for pandemic influenza.

Attachment H: Evidence compendium

A collection of literature reviews and modelling undertaken to provide evidence of the effectiveness of public health measures that might be applied to an influenza pandemic.

Attachment I: Governance Table

A detailed breakdown of roles and responsibilities across the AHMPPI stages and who will undertake them. Supports the Governance chapter.

PART 1

Overview of the National Approach

1 Executive Summary

The Australian Health Management Plan for Pandemic Influenza (AHMPPI), the national government health sector pandemic influenza plan, outlines the agreed arrangements between the Australian Government and State and Territory Governments for the management of an influenza pandemic. To support an integrated and coordinated response, it also gives a broad indication of the roles and responsibilities of the other key health sector stakeholders that would be involved in this process. It is written for government decision makers and will be used to inform operational planning in state and territory governments and the broader Australian Government.

In 2009 the *AHMPPI 2008* was used to guide Australia's response to the H1N1 pandemic. Drawing on the lessons learned in 2009 and developments in the approach to pandemics within the international community, a new version of the AHMPPI has been developed, which takes a substantially different approach.

The key factors in this plan's approach include:

- the use of **existing systems** and governance mechanisms as the basis of the response, particularly those for seasonal influenza;
- stronger linkages with **emergency response** arrangements, to capitalize on existing systems and avoid duplication;
- recognition of the potential to apply this plan to **seasonal influenza** when it threatens to overwhelm our health systems;
- the adoption of a **flexible** approach that can be scaled and varied to be proportionate to the needs experienced at the time;
- incorporation of an analysis of risks and benefits of the main public health measures which could be applied during a pandemic, to support **evidence-based decision making**;
- clear and detailed guidance on the collection of national **surveillance** data; and
- an emphasis on **communications** activities as a key tool in management of the response, including an exploration of the key principles and mechanisms to facilitate this.

Pandemic stages

An influenza pandemic represents a significant risk to Australia. It has the potential to cause high levels of morbidity and mortality and to disrupt our community socially and economically. Like any other hazard, Australia will approach this risk by undertaking activities to:

- prevent, where possible, the development of a pandemic overseas or in Australia;
- ensure we are prepared to meet the health needs of our community should a pandemic occur;
- respond promptly and effectively to minimise the pandemic's impact; and
- contribute to the rapid and confident recovery of individuals, communities and services.

The activities required to support our community during a pandemic will involve state and territory governments, the Australian Government and many other health sector parties. Coordination and communication at national level will be particularly important during the active response, when a pandemic is currently circulating in our community. The AHMPPI therefore focuses primarily on response activities and the activities required to be prepared to respond.

To clearly show how the approach will change over the course of responding to a pandemic the AHMPPI is divided into several stages.

<p>Preparedness</p>		<ul style="list-style-type: none"> • Establish pre-agreed arrangements by developing and maintaining plans; • research pandemic specific influenza management strategies; • ensure resources are available and ready for rapid response; • monitor the emergence of diseases with pandemic potential, and investigate outbreaks if they occur.
<p>Response</p>	<p>Standby</p>	<ul style="list-style-type: none"> • Prepare to commence enhanced arrangements; • identify and characterise the nature of the disease (commenced in Preparedness); and • communicate to raise awareness and confirm governance arrangements.
	<p>Action</p>	<p>Action is divided into two groups of activities:</p> <p>Initial (when information about the disease is scarce)</p> <ul style="list-style-type: none"> • prepare and support health system needs; • manage initial cases; • identify and characterise the nature of the disease within the Australian context; • provide information to support best practice health care and to empower the community and responders to manage their own risk of exposure; and • support effective governance. <p>Targeted (when enough is known about the disease to tailor measures to specific needs.)</p> <ul style="list-style-type: none"> • support and maintain quality care; • ensure a proportionate response; • communicate to engage, empower and build confidence in the community; and • provide a coordinated and consistent approach.
	<p>Standdown</p>	<ul style="list-style-type: none"> • Support and maintain quality care; • cease activities that are no longer needed, and transition activities to seasonal or interim arrangements; • monitor for a second wave of the outbreak; • monitor for the development of antiviral resistance; • communicate to support the return from pandemic to normal business services; and • evaluate systems and revise plans and procedures.

When no pandemic is occurring (the inter-pandemic period) preparedness activities will be undertaken on an ongoing basis to ensure our readiness to respond promptly, should a pandemic emerge. As part of preparedness activities monitoring for the emergence of new viruses with pandemic potential and liaison with international colleagues will be routinely carried out. The activities undertaken during preparedness will be based on existing arrangements for seasonal influenza and the monitoring of communicable diseases.

Should a virus of concern emerge, surveillance systems will monitor the situation and advise on the need to enhance our existing arrangements for managing influenza by escalating to the response stages in the AHMPPI. The decision to formally escalate the AHMPPI through each of its stages will be made by the Chair of the Australian Health Protection Principal Committee (AHPPC), in consultation with AHPPC members and with advice from advisory bodies.

Once response activities are completed arrangements will return to the Preparedness stage, to monitor for any future pandemics.

Objectives and activities

The objectives in all stages will be to:

- Minimise transmissibility, morbidity and mortality;
- Minimise the burden on/ support health systems; and
- Inform, engage and empower the public.

The activities which should be implemented will be selected by AHPPC, in consultation with relevant parties and on advice from advisory bodies. A comprehensive evidence compendium and an analysis of the key public health measures is available to support this plan to inform these decisions. As our understanding of the management of communicable diseases, immunisation and technology is constantly evolving, these support documents will be periodically revised to ensure they are providing decision makers with up-to-date and comprehensive information.

Reflecting a flexible approach, choices on implementation of public health measures may vary across states and territories to reflect the jurisdictional context, particularly in relation to timing of implementation and stand down, however negotiation within AHPPC will ensure a coordinated and consistent approach.

Proportionate response

In the past all pandemic planning was aimed at responding to a worst case scenario, similar to the influenza pandemic of 1918-19. The 2009 pandemic showed clearly the need for the flexibility to scale the response to be proportionate to the risk associated with the current disease. Although it will only be possible to quantify the overall impact of the pandemic once it has run its course, to assist planners, an estimate of the anticipated level of impact will be developed early in the response, and updated as new data becomes available. This estimate will be used to:

- guide the allocation of resources (including anticipation of when they are needed, as this will change over time);
- put in place strategies to supplement likely shortfalls (e.g. innovative options);
- reduce the risk to vulnerable people.

The level of impact that the pandemic has on the Australian community will depend on a number of factors. The most influential will be the clinical severity and transmissibility of the disease, and the capacity of the health system to cope with the demand and the need for specialist services. Three scenarios have been developed and used in this plan to assist planners interpret the influence of these factors. The scenarios look at three different pandemics: one where clinical severity is low, one medium and one high, and in each explore changes in transmissibility and health system capacity, and how this will affect the community, and therefore require different approaches and levels of resources.

Communication and consultation

The management of an influenza pandemic will require governments, health sector industry and the community to work together. Communication will be a priority under this plan, to ensure responders are provided with timely, accurate and comprehensive clinical information and advice in order to effectively manage patients; implement pandemic control measures and minimise their own risk of exposure. Consultation with responders and with the public will be essential to inform decision making.

Public communication will be used to provide an opportunity both to address any public concern caused by the pandemic and to engage the public in strategies to manage the impact of the disease. By giving the public up to date, consistent and accurate information about the status of the disease overseas and in Australia they can participate in managing the pandemic by taking steps to reduce the risk to themselves and their families. They can also make more informed decisions about work and travel, taking up health recommendations and planning for people in at-risk groups. Information about the implementation of activities and arrangements will be used to build public confidence in the capacity of health services to manage the response.

Structure of the AHMPPI

The four chapters that comprise the body of this plan (Part I) set out the broad policy approach to the management of a pandemic. Acknowledging the importance of exploring and agreeing how this policy could be implemented, the AHMPPI also includes considerable operational detail. The Operational Plan at Part II provides an operational checklist for planners, for use prior to or during a pandemic. The support documents at Part III examine activities at an individual task level and provide information to support decision making processes.

2 Introduction

This section outlines the aims of this plan, key factors in the approach taken, the context within which it has been developed and methods of achieving a response proportionate to the risk posed by the current pandemic.

Pandemics are unpredictable. When the next pandemic will occur, how rapidly it will emerge and how severe the illness will be are all unknown. What we do know is that even when the clinical severity of the disease is low, such as experienced in 2009, a pandemic can cause significant morbidity and mortality. It can overwhelm our health systems and in more severe scenarios, cause significant disruption to our economy and to society.

2.1 Aims of a national pandemic response

Australia's whole-of-government pandemic frameworks, at Australian, state and territory government levels, aim to protect Australia's social function and economy.

During an influenza pandemic, the health sector will aim to minimise the pandemic's impact on the health of Australians and our health systems. This, the Australian Health Management Plan for Pandemic Influenza (AHMPPI), is the Australian national health sector pandemic influenza plan, and contributes to these aims by:

- clarifying the roles and responsibilities within the health sector of the Australian Government and state and territory governments;
- identifying areas where national guidance and coordination will be provided, and how this will be achieved; and
- supporting decision makers to respond in a manner that is flexible, informed and proportionate to the circumstances at the time.

Across all activities the **Strategic Objectives** of this plan will be to:

- Minimise transmissibility, morbidity and mortality;
- Minimise the burden on/ support health systems; and
- Inform, engage and empower the public.

2.2 Key aspects of this plan

Since 1999 state and territory governments and the Australian Government have developed and refined a series of pandemic plans to guide how we might respond to an influenza pandemic.

Through these preparations we aim to increase the speed and efficiency of our response and to make our systems more robust in the face of increased demand. The H1N1 pandemic in 2009 gave us the opportunity to test these arrangements. This plan builds on the lessons identified and learnt in the 2009 response.

The key factors in this plan's approach include:

- the use of **existing systems** and governance mechanisms, particularly those for seasonal influenza;
- a **flexible** approach that can be scaled and varied to meet the needs experienced at the time;
- **evidence-based decision making**;
- strong linkages with **emergency response** arrangements;
- the potential to apply this plan to **seasonal influenza**, when it threatens to overwhelm our health systems;
- clear guidance on the collection of national **surveillance** data; and
- an emphasis on **communications** activities as a key tool in management of the response.

2.3 Comprehensive approach

This plan takes an emergency response approach as its framework. This approach will allow it to be readily integrated into broader emergency arrangements. It will also assist those who are implementing activities during a health emergency to communicate more easily with others outside the health sector.

Consistent with Australia's strategic approach to emergency management, the AHMPPI acknowledges the importance of seeing the management of an influenza pandemic, like any hazard, within an ongoing cycle of activities in the four areas of:

- **P**revention;
- **P**reparedness;
- **R**esponse; and
- **R**ecovery.

(Use of these terms with the initial letter in bold will indicate these areas of the emergency management cycle in this plan.)

To meet the greater need for coordination and guidance at a national level in **P**reparedness and **R**esponse, this plan will focus primarily on these two areas. To reflect the changes in priorities as the pandemic progresses and facilitate the more detailed planning required, **R**esponse activities will be further divided into three stages:

- Standby;
- Initial Action and Targeted Action; and
- Standdown.

Table 1 indicates the general focus of activities in each stage of the AHMPPI. The current status of the virus in each stage is noted in italics. To ensure that flexibility is maintained, these stages are deliberately broad. To make it easier to relate activities to these stages colours have been allocated to each and used as markers in this plan.

Table 1: Key activities in each stage of the AHMPPI

<p>Preparedness <i>No novel strain detected (or emerging strain under initial investigation)</i></p>		<ul style="list-style-type: none"> Establish pre-agreed arrangements by developing and maintaining plans; research pandemic specific influenza management strategies; ensure resources are available and ready for rapid response; monitor the emergence of diseases with pandemic potential, and investigating outbreaks if they occur.
<p>Response</p>	<p>Standby <i>Sustained community person to person transmission overseas</i></p>	<ul style="list-style-type: none"> Prepare to commence enhanced arrangements; identify and characterise the nature of the disease (commenced in Preparedness); and communicate to raise awareness and confirm governance arrangements.
	<p>Action <i>Cases detected in Australia</i></p>	<p>Action is divided into two groups of activities:</p> <p>Initial (when information about the disease is scarce)</p> <ul style="list-style-type: none"> prepare and support health system needs; manage initial cases; identify and characterise the nature of the disease within the Australian context; provide information to support best practice health care and to empower the community and responders to manage their own risk of exposure; and support effective governance. <p>Targeted (when enough is known about the disease to tailor measures to specific needs.)</p> <ul style="list-style-type: none"> support and maintain quality care; ensure a proportionate response; communicate to engage, empower and build confidence in the community; and provide a coordinated and consistent approach.
	<p>Standdown <i>The public health threat can be managed within normal arrangements and monitoring for change is in place</i></p>	<ul style="list-style-type: none"> Support and maintain quality care; cease activities that are no longer needed, and transitioning activities to seasonal or interim arrangements; monitor for a second wave of the outbreak; monitor for the development of antiviral resistance; communicate to support the return from pandemic to normal business services; and evaluate systems and revise plans and procedures.

2.4 Context of pandemic planning

This plan will sit under the Emergency Response Plan for Communicable Disease Incidents of National Significance (CDPLAN), one of the four plans under the Australian National Health Emergency Response Arrangements. It also supports the Emergency Response Plan for Communicable Disease Incidents of National Significance: National Arrangements (National CD Plan).

Guidance on the management of seasonal influenza is available in the Influenza Infection: Communicable Disease Network Australia (CDNA) National Guidelines for Public Health Units in the Series of National Guidelines (SoNGs). Much of this is also applicable to pandemic influenza and wherever possible the approach in the AHMPPI will be in line with these guidelines.

The AHMPPI acknowledges that the primary responsibility for managing the impact of a severe outbreak of influenza, or a pandemic, lies with the state and territory governments and that each jurisdiction will have its own plans and protocols. Therefore the majority of operational detail will be found in these plans.

2.5 Legal framework

Although Commonwealth biosecurity legislation and state and territory public health and emergency response laws provide a legislative framework to underpin actions that may be required, measures will rely on voluntary compliance rather than legal enforcement wherever possible. The principal areas of legislation available to support pandemic actions are described in the following subsections.

The Biosecurity Act 2015

The *Biosecurity Act 2015* authorises activities used to prevent the introduction and spread of target diseases into Australia. People reasonably suspected to have a listed human disease (LHD) specified under the Act are required to comply with a range of biosecurity measures and requests for information as directed by the Minister for Health, or a biosecurity official or human biosecurity officer as stipulated in the Act. The Governor-General also has the power to declare a human biosecurity emergency, which authorises the Health Minister to implement a broad range of actions in response. These could be applied to respond to an influenza pandemic. 'Human influenza with pandemic potential' is an LHD. Diseases can be added to the list of LHDs (as declared in the *Biosecurity (Listed Human Diseases) Determination 2016*) at any time by the Director of Human Biosecurity (DHB) at short notice. Australia's Chief Medical Officer is the DHB under the Act.

The National Health Security Act 2007

The *National Health Security Act 2007* (NHS Act) authorises the exchange of public health surveillance information (including personal information) between the Australian Government, states and territories and the World Health Organization (WHO). The National Health Security Agreement supporting the NHS Act formalises decision-making and coordinated response arrangements that have been refined in recent years to prepare for health emergencies.

State and territory government legislative powers

States and territories have legislative powers that enable them to implement biosecurity arrangements within their borders and that complement Australian Government biosecurity arrangements. They also have a broad range of public health and emergency response powers available under public and emergency legislation for responding to public health emergencies.

International legislative obligations

The International Health Regulations 2005 (IHR) is an international public health treaty that commits signatory countries to take action to prevent, protect against, control and provide a public health response to the international spread of disease. As a signatory, Australia has a range of obligations, including reporting and maintaining certain core capacities at designated points of entry.

Therapeutic Goods Act 1989

The *Therapeutic Goods Act 1989* establishes a framework for ensuring the timely availability of therapeutic goods (i.e. medicines, medical devices and biological products) that are of acceptable quality, safety and efficacy/performance. There are provisions within the legislation that operate at an individual patient level and at a program level (such as the maintenance of a National Medical Stockpile) to allow for the importation and supply of products that have not been approved for use in Australia. These products may be required to deal with an actual threat to individual and public health caused by an emergency that has occurred or to create a preparedness to deal with a potential threat to health that may be caused by a possible future emergency.

2.6 Ethical framework

In 2008 the Australian Health Protection Principal Committee (AHPPC) agreed on an ethical framework to guide health sector responses. These values will be taken into account when planning and implementing actions under this plan, and can be outlined as:

Equity	Providing care in an equitable manner, recognising special needs, cultural values and religious beliefs of different members of the community. This is especially important when providing health services to vulnerable individuals, such as Aboriginal and Torres Strait Islander peoples and people who are culturally and linguistically diverse.
Individual liberty	Ensuring that the rights of the individual are upheld as much as possible.
Privacy and confidentiality of individuals	Is important and should be protected. Under extraordinary conditions during a pandemic, it may be necessary for some elements to be overridden to protect others.
Proportionality	Ensuring that measures taken are proportional to the threat.
Protection of the public	Ensuring that the protection of the entire population remains a primary focus.
Provision of care	Ensuring that health care workers (HCWs) are able to deliver care appropriate to the situation, commensurate with good practice, and their profession's code of ethics.
Reciprocity	Ensuring that when individuals are asked to take measures or perform duties for the benefit of society as a whole, their acts are appropriately recognised and legitimate need associated with these acts are met where possible.
Stewardship	That leaders strive to make good decisions based on best available evidence.
Trust	That health decision makers strive to communicate in a timely and transparent manner to the public and those within the health system

2.7 Proportionate response

A key goal of the decision making process is to achieve a response that is proportionate to the level of risk, acknowledging that the risk is not the same across population groups. A response that is appropriate to the level of impact the pandemic is likely to have on the community, and on vulnerable populations within the community, will make the best use of the resources available and minimise social disruption.

2.7.1 Pandemic Impact

The level of impact that the pandemic has on the Australian community will depend on a number of factors.

The **clinical severity** of the disease will affect the number of people that present to primary care, and who need to be hospitalized (and consequently the burden on the health system). The clinical severity also affects the number of deaths and the level of concern within the community. As clinical severity increases, the visibility of the disease (i.e. how easy it is to be aware of cases) is likely to increase. Greater visibility of cases to medical services makes them more amenable to measures to manage the disease's impact.

The **transmissibility** of the virus between humans will affect the breadth and speed of spread across the globe and the Australian community. The transmissibility of a pandemic influenza virus is usually estimated to have a basic reproduction number (R_0) of 1.2–2.5. For communicable diseases, this is not particularly high. However, the serial interval for influenza (the time taken between generations of infection) is short (around two days), with transmission from a primary case potentially occurring before symptom onset, allowing infection to spread relatively quickly.

The **capacity of the health system** will influence the way that healthcare is provided. Australia has an excellent health system. However, there is a limit to the services that are able to be provided, which may well be tested during a pandemic. In some areas the health system already reaches capacity at peak times, such as during severe influenza seasons. A pandemic will increase the demand on specialist expertise, particularly in acute care, such as intensive care nursing, emergency medicine and ambulance services. It may also increase the demand on specialist equipment, some of which requires specialist training to implement and is of limited availability, such as extracorporeal membrane oxygenation (ECMO). Demand on primary health care will also increase, exacerbated by the need to attend to patients affected by the changes in availability of services at hospitals.

The **effectiveness of interventions**, such as antivirals, will affect individual health and the levels of morbidity and mortality that need to be managed by the health system. Ultimately the availability of a customised pandemic vaccine will be the greatest tool in reducing the impact. Interventions that change behaviours, such as hand hygiene will also influence the impact of the disease.

The **vulnerability** of our population will influence the spread and clinical severity of the disease. Vulnerability is unique and will make comparisons with the experience of the pandemic overseas indicative only. As the pandemic will be caused by a novel virus, the relative lack of immunity in the population (compared to seasonal influenza) will make it more vulnerable than would be the case with seasonal influenza (where there is usually some cross-immunity from previous seasonal strains). It is also possible that parts of our population, such as the elderly, may have immunity conferred from previous exposure to a similar virus, while the broader population is vulnerable to the disease.

On the basis of seasonal influenza and experience from past pandemics, certain groups are expected to be at increased risk of complications of influenza infection (referred to in this plan as 'at-risk groups'). According to the *Australian Immunisation Handbook (10th Edition 2015)*, at-risk groups include pregnant women, people who are immunocompromised, people with chronic respiratory conditions, cardiac disease, Down syndrome, diabetes mellitus, chronic renal failure, chronic neurological conditions, alcoholism, haemoglobinopathies, chronic inherited metabolic diseases, people who are obese, children receiving long-term aspirin therapy, Aboriginal and Torres Strait Islander peoples, children under 5 and people aged over 65 years. At-risk groups will need to be confirmed when knowledge of the virus becomes available, but it is expected that the impact on vulnerable populations will be greater than that on the broader population. Mitigation of the risk to these populations will be a high priority. Many other factors can influence the vulnerability of individuals during a pandemic, including overall health, immunological response, cultural attitudes (e.g. to vaccination, mask wearing), access to healthcare, homelessness and mental health and resilience.

2.7.2 Application of pandemic impact levels to decision making

Although it will only be possible to quantify the overall impact of the pandemic once it has run its course, as part of surveillance activities, an estimate of the anticipated level of impact will be made early in the response, and continually updated as data availability allows, and used to help planners:

- allocate resources where they are needed (including anticipation of when they are needed, as this will change over time);
- put in place strategies to supplement likely shortfalls (e.g. innovative options);
- reduce the risk to vulnerable people;
- minimise the disruption to the community; and
- provide a response that is proportionate to the level of impact.

Characterisation of the virus will be undertaken as early as possible in the pandemic and revised regularly as more information becomes available. While all the factors mentioned above will be considered as part of the decision making process, they will have different degrees of influence.

Clinical severity is likely to be critically important in making an estimate of impact. It will strongly impact on the morbidity and mortality at an individual and population level, the burden on the health system and the concern within the community. Explanations of impact in terms of clinical severity are also easily understood at a personal and public health level. As clinical severity increases, the following will also increase:

- the demand for high end services, such as Intensive Care Unit (ICU), paediatric and respiratory care (associated with this will be increased demand for specialised equipment and health care professionals, such as ECMO and ICU nurses). High end services are areas likely to increase the demand on support services, such as laboratories, much more than increased demand in general wards;
- the demand for services associated with management of the deceased;
- the importance of informing and supporting at-risk groups;
- the importance of measures to promote prompt presentation and diagnosis, while minimising opportunities for transmission;
- the importance of building confidence within the community;
- the proportion of infected individuals seeking treatment, which means the public health interventions to reduce ongoing transmission that rely on identification of cases will likely be more effective.

Following clinical severity, transmissibility will be considered, to help determine the likely speed of spread and the timing of the demand on health services, and further define the impact of the pandemic on the population as a whole. As transmissibility rises:

- the timeliness of measures to limit spread becomes more critical (as the window of opportunity is smaller);
- the demand for health services rises more quickly;
- health services and response measures need to be scaled up more quickly;
- the peak burden and final total burden on the health system will be higher;
- the overall duration of the pandemic will be shorter;
- assessments and decisions will need to be made more quickly (epidemiological and individual).

Figure 1 provides some examples of how previous pandemics could be characterised in terms of clinical severity and human to human transmissibility.

Figure 1: Contribution of transmissibility and severity on population impact of previous pandemics.

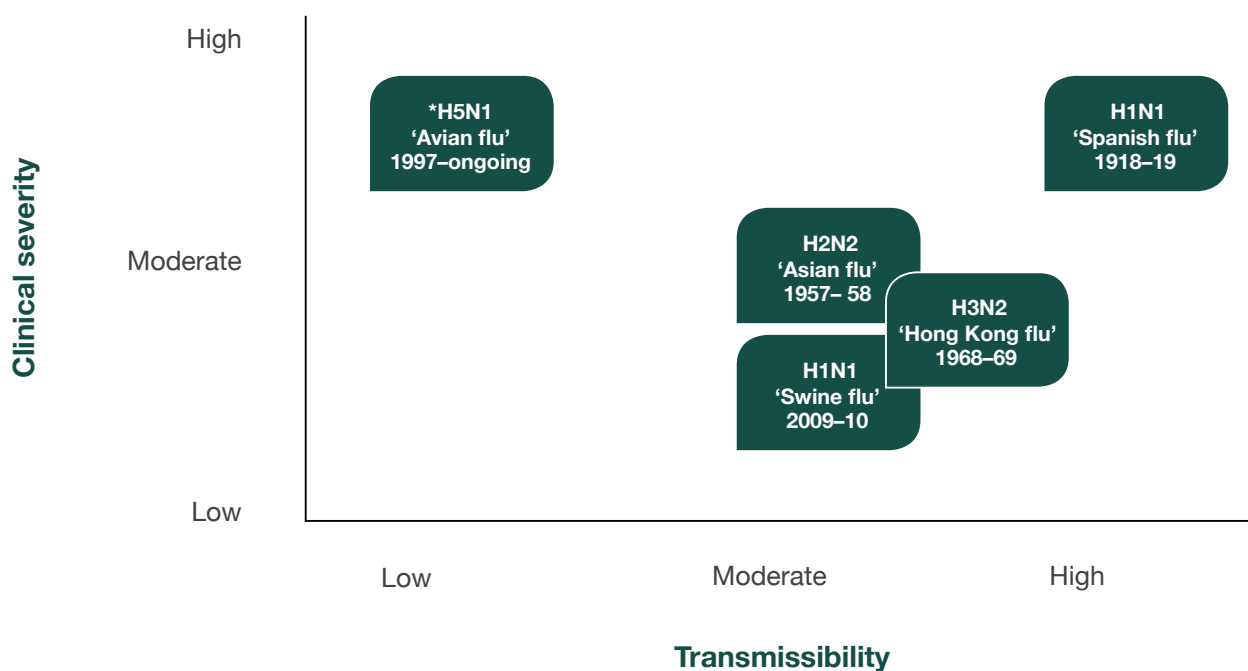

*H5N1 1997-ongoing is not a true pandemic but has been included for demonstration purposes.

The significance of transmissibility will vary depending on the stage of progress of the pandemic. It should also be considered that, as an influenza pandemic will be caused by a novel virus, there will be higher than usual vulnerability in the population to the virus. Community transmission is likely to become widespread quickly. The window of opportunity for measures aimed at controlling transmission may therefore be small.

The capacity of the health system will also be considered to determine the degree to which systems will be able to manage the increased demand and which measures would need to be put in place to best use available resources.

Indicators such as notifications, hospitalisations and availability of ICU beds may be used to determine the transmissibility, clinical severity and health system capacity respectively.

2.7.3 A qualitative description of three different levels of pandemic impact

Each pandemic is unique and the clinical severity and transmissibility is likely to vary each time. Health system capacity will vary between and within jurisdictions, according to the season and between different health services. To illustrate how differences in these three factors may impact differently on the community, and therefore require different approaches and levels of resources, three scenarios have been described in the following sections.

The Guide to Implementation at Attachment F provides suggestions of the types of public health measures that would be appropriate in these different situations.

Scenario one

If clinical severity is low

The majority of cases are likely to experience mild to moderate clinical features. People in at-risk groups may experience more severe illness. Strategies to support at-risk groups may be required (e.g. aged care, infants, Aboriginal and Torres Strait Islander peoples, remote communities). At the peak of the pandemic, and increasingly when transmissibility is higher, primary care and hospital services are likely to be stretched to coping capacity in areas associated with respiratory illness and acute care. Existing legislation is likely to be sufficient to support activities. The level of impact on the community may be similar to severe seasonal influenza or the H1N1 pandemic 2009.

Scenario two

If clinical severity is moderate

Young healthy people and people in at-risk groups may experience severe illness. The number of people presenting for medical care is likely to be higher than for severe seasonal influenza and primary care and hospital services will be under severe pressure, particularly in areas associated with respiratory illness and acute care. Non-urgent procedures and activities will need to be scaled back. Surge staffing and alternate models of clinical care, such as flu clinics may need to be employed to cope with increased demands for healthcare. Pressure on health services will be more intense, rise more quickly and peak earlier as the transmissibility of the disease increases. Healthcare staff may themselves be ill or have to care for ill family members, further exacerbating pressures on healthcare providers.

Additional strategies to support at-risk groups may be required (e.g. aged care, infants, Aboriginal and Torres Strait Islander peoples, remote communities). Pandemic emergency legislation may be needed to support pandemic specific activities. The level of impact may be similar to the 1957 H2N2 Asian flu.

Scenario three

If clinical severity is high

Widespread severe illness will cause concern and challenge the capacity of the health sector. Areas such as primary care, acute care, pharmacies, nurse practitioners and aged care facilities will be stretched to capacity to support essential care requirements. Heavy prioritisation will be essential within hospitals to maintain essential services and mortuary services will be under pressure. The demand for specialist equipment and personnel is likely to challenge capacity. Pressure on health services will be more intense, rise more quickly and peak earlier as the transmissibility of the disease increases. Healthcare staff may themselves be ill or have to care for ill family members, further exacerbating pressures on healthcare providers.

Secondary care services, such as blood services and diagnostic services will be challenged to maintain capacities and the community focus will be on maintaining essential services. Pandemic emergency legislation may be needed to support pandemic specific activities. The level of impact may be similar to that of the 1918 H1N1 Spanish flu.

These scenarios characterise the impact on the Australian community as a whole.

2.8 Planning assumptions

Planning for a pandemic is based on a set of assumptions defined using the best scientific and medical evidence. In the early stages, when little is known about the disease, these assumptions (along with relevant information from overseas) will be the basis for decision making. As the pandemic emerges these assumptions must be reassessed as quickly as possible and revisions used to decide if adjustments to **R**esponse activities are required or a more flexible, tailored use of resources could be implemented.

The planning assumptions supporting this document are provided in detail in the Evidence Compendium (Attachment H) of this plan. The Surveillance Plan at Attachment G details how and when these assumptions should be tested during the response.

2.9 Participating parties

This plan is written for government decision makers and will be used to inform operational planning in state and territory governments and the broader Australian Government. The primary parties to the AHMPPI will be the Australian Government Department of Health (Department of Health) and State and Territory Health Departments.

The participation of, or coordination with other government agencies at Australian Government and State and Territory Government level will also be necessary to implement many of the activities in this Plan. Commitment to this process is captured in the National CD Plan. The Australian Government Department of Agriculture will be particularly important in the implementation of border health measures. The Department of Home Affairs may also be involved.

Non-government parties, such as general practitioners (GPs), nurses and pharmacists will also be involved in responding to a pandemic. Recommendations concerning their roles have been included in the Governance Chapter of this plan to guide coordination and integration. It is acknowledged that healthcare practices will rely on the hard work of teams of individuals to implement pandemic measures and that these teams will be made up of people with a broad range of skills.

2.10 Review and amendment

The support documents in the AHMPPI are intended to be 'living' documents and will be regularly updated and refined to make sure they keep up with current ideas and evidence.

The Chief Medical Officer, after appropriate consultation, may approve amendment to the AHMPPI as needed to meet the current circumstances. Fundamental changes to the approach taken will be referred for endorsement to health ministers.

3 Escalation

This chapter explains when arrangements under the AHMPPI will be used and how escalation through the AHMPPI stages will occur.

3.1 Seasonal Influenza Arrangements

Influenza is a contagious disease of the respiratory tract which occurs seasonally each year. Due to some pre-existing immunity induced by exposure to previously circulating seasonal strains of influenza virus, most people only suffer a self-limiting illness, lasting from a few days to several weeks. Influenza can lead to complications and for some, such as older people, pregnant women, people with poor immune systems and people with pre-existing respiratory, cardiac and endocrine disease—influenza can be a significant disease and cause death. It can also cause the death of healthy adults and children.

GPs and other health providers, such as nurses, Aboriginal Community Controlled Health Services (ACCHSs), pharmacists and aged care providers manage the bulk of people with influenza within the community. Public health units and communicable disease control services in state and territory health departments manage outbreak response, collect public health surveillance data, administer vaccination programs, develop and implement health promotion and public communications, and provide significant support to clinical services and aged care facilities. Ambulance services, hospital emergency and respiratory wards, and intensive care units support people with complications. Laboratories provide testing processes, advise on management of resources and public health approaches, and participate in research. Surveillance systems and public health units investigate and support management of outbreaks and provide important public information on risk reducing strategies. States and territories work together with the Australian Government and primary healthcare providers under the National Immunisation Program to support access of vulnerable groups to influenza vaccinations.

These systems are well developed and processes are refined continuously as outbreaks are managed each year.

3.2 Escalation from existing arrangements

These existing arrangements form the basis for the clinical and public health management of pandemic influenza. Emergency management processes, in particular the Australian Government Crisis Management Framework (AGCMF), will be used as the basis of governance arrangements. Existing surveillance systems will be used to monitor the emergence of novel influenza viruses, and form the basis for gathering information to guide decision making throughout the pandemic.

While there are many similarities to seasonal influenza, there are also significant differences in managing a pandemic. Common objectives to minimise transmission, morbidity and mortality will remain, but there will also be a need to:

- **Rapidly gather, synthesise and share information** on the epidemiology, virology and severity of the disease to inform treatment and planning;
- **Mobilise, reallocate and coordinate resources**, as the low immunity to the virus within our population leads to greater numbers of people presenting for different levels of medical assistance; and
- **Communicate a consistent and timely message**, to engage the community effectively in pandemic response measures and to build trust and confidence when there is broader vulnerability.

Existing systems will need to be adapted and enhanced to support these new priorities. Some systems may be extended (such as through surge staffing) and, where outside the normal scope, some will be augmented (through methods such as recruitment of additional expertise). The greater complexity of systems required to respond to a pandemic will increase the need for national coordination.

The AHMPPI provides an agreed approach to provision of a coordinated and consistent response and a decision to escalate under the AHMPPI from existing arrangements will signal that participating parties should:

- commence use of agreed governance and communication arrangements to manage this type of threat;
- undertake their roles and responsibilities as detailed in this plan;
- advise stakeholders of the approach that will be taken by national, state and territory health departments to respond to the situation; and
- put in place a process to allocate resources and justify re-prioritisation of existing activities to support the pandemic response.

3.3 Escalation across stages

When no pandemic is occurring Preparedness activities will be undertaken on an ongoing basis to ensure our readiness to respond promptly should a pandemic emerge. As part of Preparedness activities monitoring for the emergence of new viruses with pandemic potential will be routinely carried out. Should a virus of concern occur, surveillance systems will be used to investigate whether it is advisable to enhance our existing arrangements for managing influenza, as agreed in the AHMPPI.

The escalation from existing arrangements will progress across the AHMPPI stages, reflecting the changes in priorities as the pandemic develops. A detailed discussion of the types of activities that may be considered in each stage is available in the Implementation chapter. The activities associated with each stage may be implemented as determined by the needs of the situation and may vary across jurisdictions.

The decision to formally escalate the AHMPPI through each of its stages will be made by the Chair of AHPPC, in consultation with AHPPC members. AHPPC will assess the need for enhanced arrangements and determine the appropriate AHMPPI stage by considering advice from the CDNA, the Public Health Laboratory Network (PHLN), the Department of Health, state and territory government health departments (S/T HD) and/or other advisory bodies. (This process is described in the Governance Chapter.) The plan may be escalated directly from Preparedness to the Initial Action or Targeted Action stage if AHPPC considers this warranted by the circumstances.

Triggers

Examples of events that might warrant escalation include:

- declaration of a pandemic by the WHO;
- advice from a credible source that sustained community transmission of a novel virus with pandemic potential has occurred; and
- notification from a jurisdiction that assistance in responding to severe seasonal influenza may be required, including an explanation of why the need cannot be met from state/territory resources. AHPPC will determine whether this is an appropriate basis for escalation.

The National Incident Room (NIR) in the Department of Health will function as the National Health Sector Emergency Operations Centre.

3.4 Activation of other plans

The AHMPPI stages will be independent of activation of whole-of-government or jurisdictional plans. It is also independent of the WHO Pandemic Phases, as these are informative in giving an overview of the global progress of the pandemic, but not for guiding response management at an individual country level.

3.5 Enhanced arrangements

While the AHMPPI remains in Standby, Initial/Targeted Action or Standdown stages:

- the National Focal Point in the Department of Health will liaise with the WHO;
- the NIR will provide agencies with regular Situation Reports;
- the NIR will advise relevant Australian Government and state and territory health services of any change of stage;
- the NIR will coordinate communications;
- The Department of Health will coordinate liaison with other Australian Government agencies;
- The Department of Health will advise the Minister for Health of progress under the Plan;
- S/T HD will coordinate liaison with other government parties and response stakeholders in their jurisdiction;
- Surveillance activities will be conducted as outlined in the Surveillance Plan at Attachment G;
- Communications will be conducted as outlined in the Communications Chapter.

4 Governance

This chapter outlines the roles and responsibilities of stakeholders and key committees, and describes decision making and consultation processes.

4.1 Roles and responsibilities

A clear understanding of the roles and responsibilities between parties responding to an influenza pandemic will support quick decision making and efficient, coordinated use of resources. This section summarises the roles and responsibilities of the Australian Government in key aspects of managing a pandemic, the roles and responsibilities of the state and territory governments, and where roles and responsibilities are jointly shared by these two parties. To reinforce important linkages with these stakeholders, this chapter also outlines the broad roles of other health sector parties. Detailed guidance on roles and responsibilities is provided in the table at Attachment I.

4.1.1 Planning

Minimising the impact of a pandemic on Australian communities and on the health system requires coordinated and careful planning of measures to control the spread of an influenza pandemic. The Australian Government maintains the AHMPPI to prepare for and respond to an influenza pandemic, with input from states and territories, and other health sector stakeholders. This plan is regularly reviewed.

States and territories also develop consistent and comprehensive operational plans for the public health response, and the health service response within their jurisdictions.

Other health sector stakeholders are responsible for developing their own pandemic plans in accordance with national and jurisdictional arrangements and for incorporating pandemic influenza into overall business continuity plans.

At all levels, planning will consider what is needed to protect the most vulnerable members of our communities, and address the needs of special groups, such as the aged care sector and Aboriginal and Torres Strait Islander peoples.

4.1.2 Pandemic influenza surveillance

Australian Government is responsible for developing and maintaining systems to monitor communicable disease activity domestically and internationally and for communicating relevant information. Once a pandemic has arrived in Australia, these systems will be used for monitoring and analysis. Working together with state and territory representatives, the Australian Government will assess the risk of any potential pandemic threats to inform decision making about appropriate actions.

State and territory governments are responsible for collecting influenza surveillance data to contribute to the national picture and to inform the jurisdictional public health response. They will also monitor surveillance data to identify when seasonal or pandemic influenza has the potential to overwhelm the capacity of jurisdictional systems to manage the response.

Other health sector stakeholders will play a key role in surveillance activities such as sentinel surveillance and influenza virus subtyping and characterisation.

4.1.3 Provision of Clinical Services

The Australian Government will coordinate allocation of available national resources required for clinical care.

The Australian Government and state and territory governments will work together to develop new models of care to manage patients and agree on influenza triage criteria (if required); tailor infection control guidelines to the risks relevant to the pandemic virus as required; ensure provision of primary health care is adapted to any changes in the needs of vulnerable groups during the pandemic; and consider and respond to requests for health assistance.

State and territory governments have primary responsibility for establishing and maintaining public health services, public hospitals and laboratories. They are responsible for the operational aspects of clinical care responses and have primary responsibility for the management of cases. They will collaborate with relevant organisations to fill identified service provision gaps; support hospitals in coping with increased demand by considering opening more beds, changing staff to patient ratios; cancelling elective procedures or working in partnership with local private hospitals to manage urgent cases where appropriate; implement new models of care as required; coordinate allocation within their jurisdiction of available resources required for clinical care; and where possible, share clinical resources where and when needed.

Other health care stakeholders are responsible for service provision and linking with and participating in the clinical care network by sharing resources; implementing national care guidelines (including triage protocols if required) and delivering pandemic control measures where required. They will implement patient triage, manage patients and provide after-hours care as required; coordinate locally between services; collaborate with state and territory health authorities to identify and fill local gaps in services, particularly where there are vulnerable populations and implement new models of care according to pandemic influenza policy.

4.1.4 Implementation of public health measures

The Australian Government is responsible for ensuring the resources and systems required to mount an effective national response are readily available; for international border activities; and for ensuring that Australia meets its international obligations. This includes maintaining the NIR; the National Medical Stockpile (NMS) and IHR core capacities including maintenance of the National Focal Point (NFP).

The Australian Government will also be responsible for residential aged care facilities; working with other healthcare providers to set standards to promote the safety and security of people in aged care and other institutional settings; and establishing and maintaining infection control guidelines; healthcare safety and quality standards. The Australian Government will fast-track assessment and approval of the customised pandemic vaccine; procure vaccines; develop a national pandemic vaccination policy and a national pandemic immunisation program; and communicate immunisation information on the program to the general public and health professionals.

The Australian Government and state and territory governments will work together to provide advice and leadership on the appropriate methods and timing for implementing public health measures. They will develop communication strategies and resources for influenza immunisation and coordinate implementation of pandemic influenza immunisation programs. They will also contribute to building linkages between human and animal health resources and activities.

State and territory governments are responsible for the operational aspects of public health responses. They will undertake contact tracing; coordinate distribution of antiviral drugs and disseminate protocols on the use of antivirals; implement social distancing measures as per national recommendations and local risk assessment; and implement infection control guidelines and healthcare safety and quality standards. They will establish systems to promote the safety and security of people in aged care and other institutional settings and support outbreak investigation and management in residential aged care facilities, schools, prisons and other institutions.

State and territory governments will develop and validate specific pandemic influenza virus tests; undertake pandemic influenza laboratory testing as required to monitor the pandemic and for individual patient care; implement testing protocols to support case management, surveillance needs and to preserve laboratory capacity; support and undertake pandemic influenza point of care testing if recommended, and coordinate point of care testing data management and reporting.

State and territory governments will maintain IHR core capacities and communicate public health events of national significance to the NFP; support implementation of border measures by providing of disease control expertise and health care services to ill travellers; implement the national pandemic immunisation program; manage jurisdictional distribution of the NMS and assess the need for a jurisdictional medical stockpile and, if relevant, establish and maintain it.

Other health sector stakeholders will contribute to IHR core capacities; provide input on needs related to national stockpile items; maintain stocks and use of, personal protective equipment as appropriate for infection control requirements; and report adverse events following immunisation or following the administration of influenza antiviral drugs to the state health authority and/or the Therapeutic Goods Administration (TGA).

Other health sector stakeholders will implement infection control guidelines and healthcare safety and quality standards; and implement protocols and procedures to promote the safety and security of people in aged care and other institutional settings according to national standards. They will also administer influenza vaccine according to national guidelines; and provide community education on influenza vaccination programs including education with hard-to-reach groups and at-risk populations.

4.1.5 Researching, planning and building specific pandemic influenza control strategies

The Australian Government will commission research on the effectiveness and impact of public health measures. National, state and territory governments will use this information to inform their plans. Other health sector stakeholders will provide advice on the feasibility and impact of pandemic control measures; and support dissemination and implementation of national advice on the measures, such as the use of antiviral drugs and influenza vaccines.

4.1.6 Communication

The Australian Government is responsible for national communications to the public and the health care sector at a national level, with direct responsibility for communications with the primary care sector. It is also responsible for reporting to and liaison with the WHO as required under the IHR and sharing information from the WHO, from surveillance and other sources with relevant stakeholders. The Australian Government will also disseminate relevant tailored information to aged care and other residential facilities through approved providers and regulatory processes and liaise with Australian Government education authorities concerning public health measures related to schools.

The Australian Government will coordinate the National Health Emergency Media Response Network (NHEMRN), through which they will work with state and territory governments to ensure comprehensive sharing of information and consistent messaging. The Australian Government and state and territory governments are jointly responsible for the sharing information on resource availability and providing advice on case and contact management, chemoprophylaxis, vaccination, quarantine/isolation and pandemic risk assessment.

State and territory governments are responsible for jurisdictional and local communications to the public and the health care sector. They are also responsible for reporting issues to the NIR which might require a coordinated response and/or as required for reporting under the IHR.

Other health care stakeholders have a responsibility to provide input into decision making fora and to communicate pandemic information and key messages to the public.

The Communications Chapter contains more detail about communication during a pandemic.

4.1.7 Coordination

The Australian Government will coordinate national pandemic measures and allocate available national health resources across the country. It will support the health response in any jurisdiction if jurisdictional capacity becomes overwhelmed.

The Australian Government and state and territory governments will work together to consider surveillance, resource and political information to determine whether and when a national response is required; advise on thresholds for escalation; share information on resource availability and coordinate access to resources to maximise the effectiveness of the response.

State and territory governments will coordinate and provide influenza healthcare services including assessment and treatment centres as required.

Other health care stakeholders will deliver pandemic health measures as part of the coordinated response and maintain business continuity of essential services.

4.1.8 Standdown and evaluation

The Australian Government will coordinate the stand down of enhanced measures; manage the transition of pandemic specific processes into seasonal influenza arrangements; and undertake public communication regarding changing risk and the stand down of measures.

The Australian Government and state and territory governments will work together to determine when to cease or reduce measures and agree appropriate messaging for responders and the public concerning scaling down of measures.

State and territory governments will implement stand down of measures taken within the state or territory; manage the transition of pandemic specific processes into seasonal influenza arrangements; and undertake jurisdictional public communication regarding changing risk and stand down of pandemic measures.

Other health care stakeholders will advise on the timing and impact of reducing enhanced clinical influenza services; support stand down of measures and manage the transition of influenza specific processes into seasonal influenza arrangements; and participate in communicating public messages regarding changing risk and stand down of pandemic measures.

All parties will be responsible for evaluating pandemic processes and implementing changes as appropriate.

4.2 Decision making and consultation

Figure 2: Whole of Government, health sector, health advisory and consultative committees involved in decision making for an influenza pandemic.

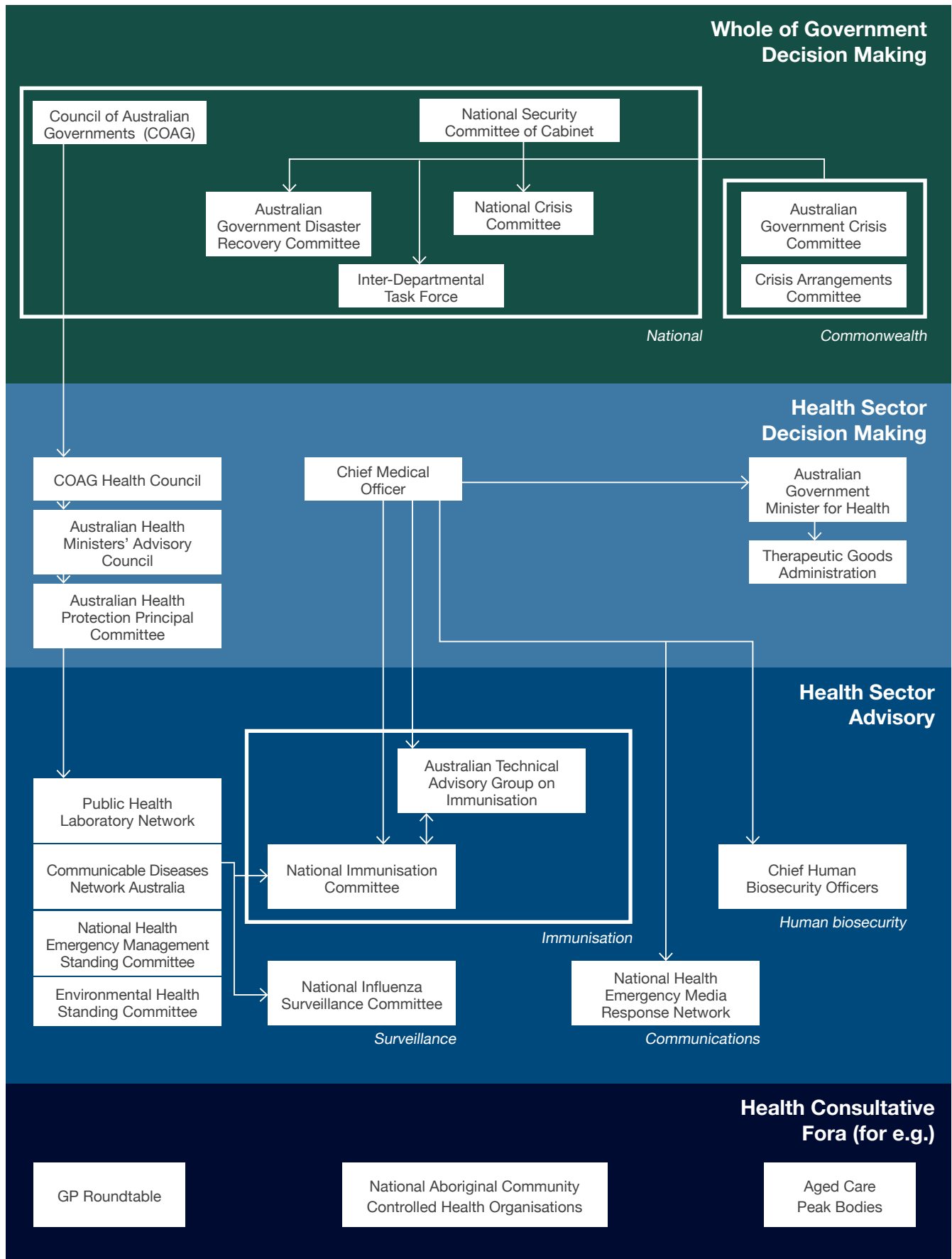
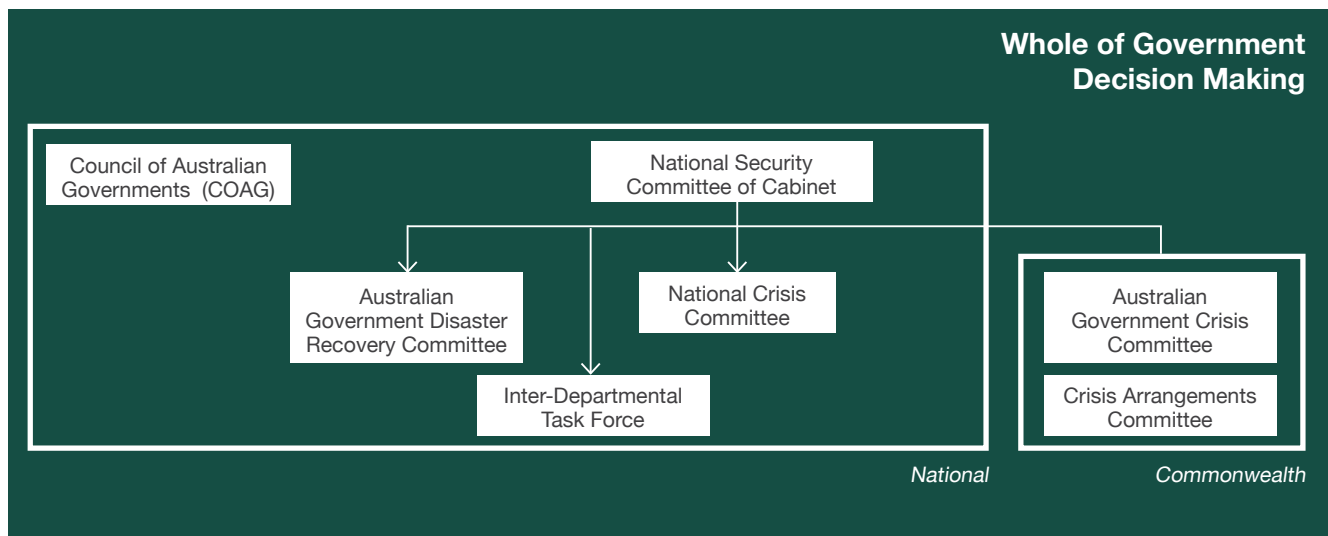

Figure 2 highlights the key WoG, health sector, health advisory and consultative committees involved in decision making for an influenza pandemic. A more detailed description is included in Attachment B of this plan.

The management of an influenza pandemic will require governments, health sector industry and the community to work together. Consultation will be essential to inform decision making, which will need to be rapid and coordinated.

4.2.1 Whole of government (WoG) decision making structure

Figure 3: Outline of whole of government decision making structure.



A severe pandemic will disrupt Australia’s social and economic functioning. Maintaining essential services may require a whole-of-government response, incorporating agencies at the Australian Government and state and territory government level. For an influenza pandemic, decision making and consultation at this level in relation to an influenza pandemic will be in line with existing emergency arrangements described in the AGCMF. The primary forum for coordinating the cross-government response will be the National Crisis Committee (NCC). The NCC will consolidate information and coordinate information exchange and advice to ministers. It will also coordinate ministerial decisions across the Australian Government, State and Territory and local governments. The Australian Government Crisis Committee (AGCC) will coordinate the response across the Commonwealth.

The National CD Plan outlines the roles and responsibilities of the Australian Government, States and Territories and Local Governments. It also details agreed coordination arrangements for the management of communicable diseases of national significance and their consequences.

When information obtained and activities implemented under the AHMPPI may have implications outside the health sector, advice regarding this will be forwarded to the NCC for consideration.

4.2.2 Ministerial responsibilities

Under the AGCMF, the Australian Government Minister for Health is the lead minister for the Australian Government response to a human influenza pandemic. As a member of the COAG Health Council (CHC), the Minister for Health is also involved in the approval of Preparedness activities, through the endorsement of plans and arrangements.

The Australian Government Minister for Health also has powers under the *Biosecurity Act 2015* to assist with managing the risk of an LHD entering, emerging or establishing itself in Australian territory. These include:

- Determining international entry requirements (and exit requirements)
- Determining preventative biosecurity measures
- Recommending the declaration of a human biosecurity emergency under the Act (and utilising the emergency powers once an emergency has been declared)

Should circumstances warrant it, the AGCMF notes that the Prime Minister may assume primary responsibility for leading the Government's response. Under these circumstances, the Prime Minister is also likely to consult with the leaders of affected states and territories to ensure a coordinated national response.

4.2.3 Health sector decision making structure

Figure 4: Outline of health sector decision making structure.

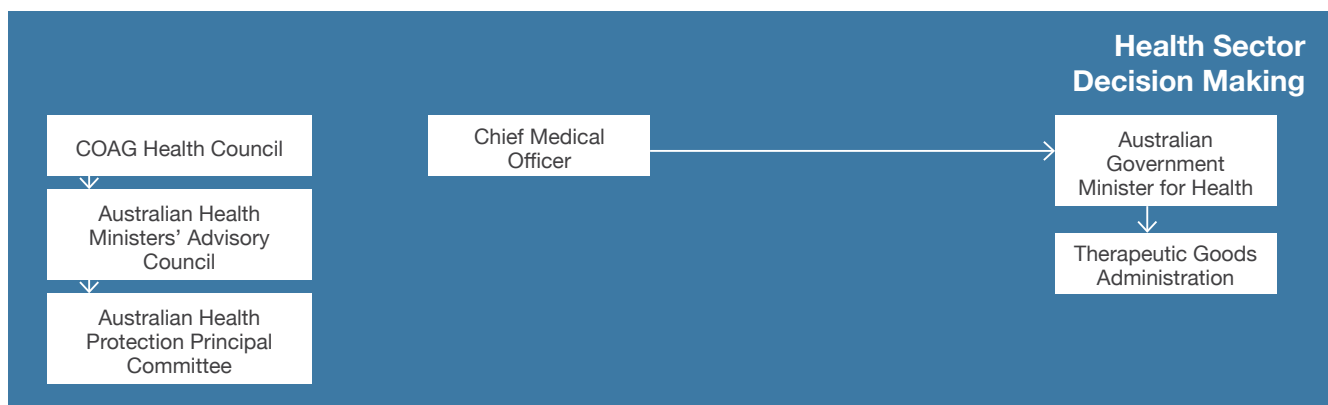

For the development of policy related to management of a pandemic, the CHC represents the highest decision making body. AHPPC will manage implementation of the national health sector response, in consultation with relevant stakeholders, and provide health sector advice to the AGCC and NCC as appropriate.

4.2.4 Health sector advisory groups

Figure 5: Outline of health sector advisory groups that support decision makers.

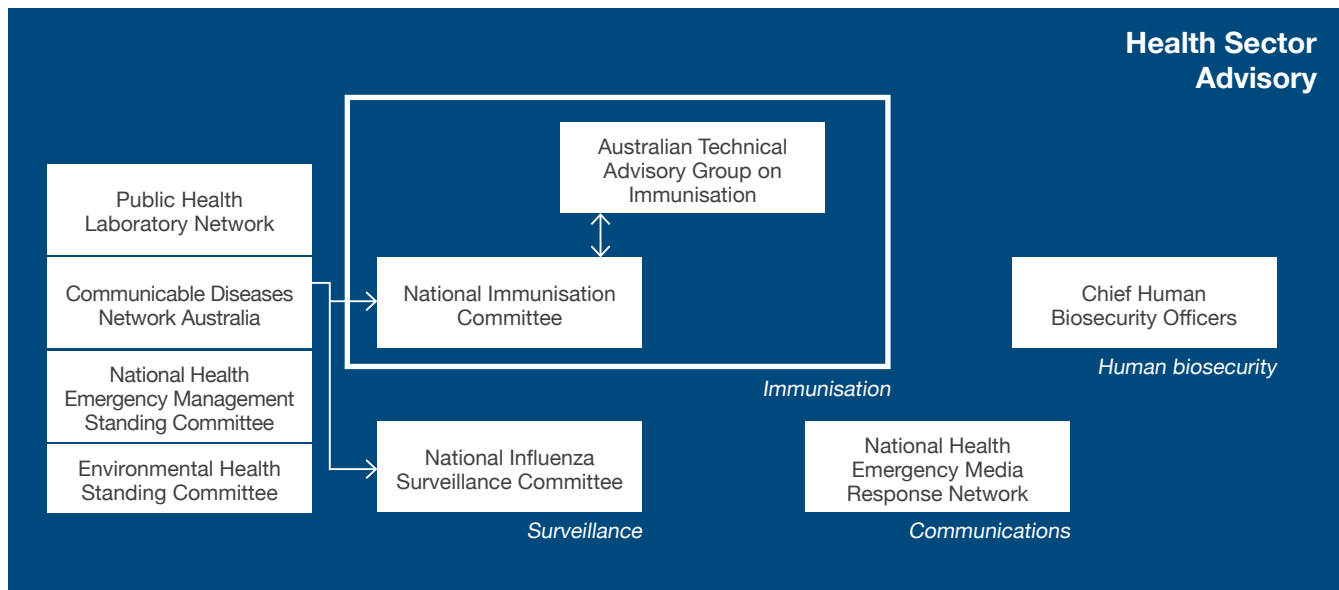

The following key committees will support decision making:

- PHLN will provide leadership in guiding human health microbiology and laboratory practice;
- CDNA will provide leadership in surveillance, the analysis of epidemiological information and strategies related to management of communicable disease;
- National Influenza Surveillance Committee (a standing committee under CDNA) will provide leadership in guiding the implementation of influenza specific surveillance activities and strategies;
- the National Immunisation Committee will provide leadership in guiding implementation of immunisation measures;
- Australian Technical Advisory Group on Immunisation will provide advice technical advice on immunisation issues; and
- Chief Human Biosecurity Officers (CHBOs) will provide advice to the Chief Medical Officer (as the DHB) on human biosecurity matters at the international border.

4.2.5 Health sector consultation

Figure 6: Outline of Health Consultative Fora

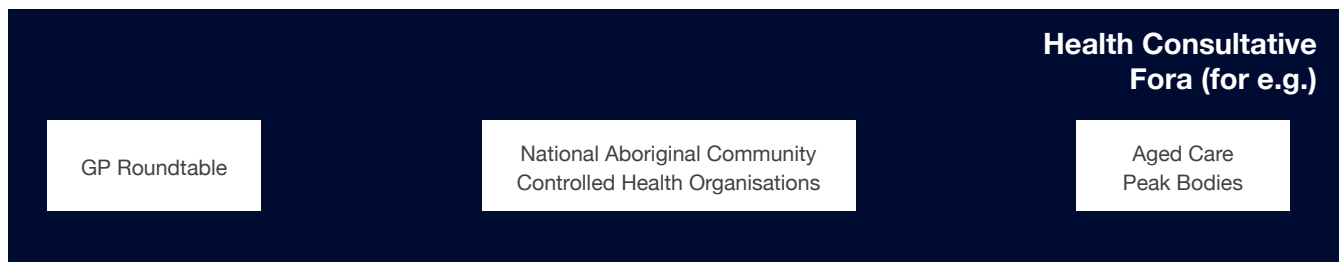

Consultation will be integral to decision making regarding the approach to managing an influenza pandemic. Wherever possible, this will be conducted through existing channels. Key advisory committees, in addition to providing expert advice will also be used as vehicles for consultation in their field of expertise.

Consultative fora and peak bodies, such as aged care peak bodies, key national primary care organisations, national nursing organisations, representatives of medical specialist colleges and pharmaceutical organisations will be used to reach key non-government health sector areas. Feedback from these organisations—which will reflect the on-the-ground experience of health sector and public concerns, and evidence of the effectiveness of approaches and specific interventions—will be input into decision making processes to better tailor the response to community needs. Communication strategies are further described in the Communications chapter.

4.2.6 Decision making processes under the AHMPPI

The AHMPPI will guide the management of an influenza pandemic at the national health sector level, representing an approach agreed between the Australian Government and state and territory governments.

Key decisions within the scope of the AHMPPI will primarily concern the following issues:

- the overall response approach;
- the appropriate stage for the AHMPPI, according to the current circumstances;
- the selection of measures appropriate for implementation at that stage (including standdown of existing activities);
- key messages for communications measures; and
- coordination of sharing of resources.

Reflecting a flexible approach, choices may vary to reflect the jurisdictional context, particularly in relation to timing of implementation and stand down, however negotiation within AHPPC will ensure a coordinated and consistent approach.

To support AHPPC in the management of these decisions a Decision Support Map (Attachment D) has been developed which provides a quick reference for noting:

- the key national level decisions likely to be required in each stage;
- the triggers prompting these decisions;
- some general background regarding each decision.

The Decision Support Map also includes a template for identifying key communications messages and an example of how this template might be applied.

4.2.7 Selection of public health measures

The selection of public health measures will be one of the most important functions of AHPPC. The following questions may be used to guide selection:

1. Will this action contribute to meeting the strategic objectives?
2. Will it be the best use of current resources?
3. Will this be proportionate to the likely impact of the pandemic?
4. When would it be most effective to implement this measure?

To ensure that the appropriate expertise is available to support AHPPC, relevant health advisory bodies such as CDNA, PHLN or the Department of Health, will provide a set of recommendations for consideration at key decision points. Only a broad recommendation will be made for question 2, as this will depend on the resources available at the time in the Australian Government or relevant jurisdiction.

The continuing appropriateness of measures will be regularly reviewed as more information becomes available across the progress of the pandemic. A regular set time for review (frequency will depend on the progress of the pandemic), such as weekly, will assist building awareness of changes made.

4.2.8 Formulating recommendations for AHPPC

To assist advisory groups to develop recommendations regarding selection of public health measures the AHMPPI provides two sets of tools: a Menu of Actions and a Guide to Implementation.

4.2.8.1 Menu of Actions

Based on the previous application of health measures to pandemics (in Australia and overseas); research and modelling; and application to seasonal influenza or other related diseases, a Menu of Actions has been developed. This Menu lists the main public health measures which could be applied to respond to an influenza pandemic (see Attachment E). This list is divided into the following broad categories:

- **pharmaceutical measures:**
antivirals, candidate pandemic vaccines (vaccines based on a strain of influenza virus considered to have pandemic potential) and customised pandemic vaccines (vaccines based on the actual pandemic virus);
- **social distancing;**
community level interventions to reduce normal physical and social population mixing, in order to slow the spread of a pandemic throughout society;
- **border measures:**
measures that can be taken at airports and seaports to delay the spread of illness to or from a ffected countries (or jurisdictions); and
- **infection control measures:**
measures to promote hand hygiene, cough/sneeze etiquette; the use of personal protective equipment (PPE).

Communications measures are used across the categories. Each category lists the key actions in this area (such as school closures, voluntary isolation or working from home, in the social distancing category) and for each of these actions a summary table is available which outlines suggested factors relevant to determining suitability for implementation.

These factors include:

- rationale and objective;
- evidence of effectiveness*;
- risks and benefits;
- direct and secondary costs;
- likely acceptability;
- practicalities; and
- timing.

**The evidence of effectiveness cited in these summaries is based on a series of commissioned reports and represents the best available information at the time. This section of the AHMPPI will be periodically revised to ensure the evidence presented is up to date. Links to these reports can be accessed through the summary tables or through the Evidence Compendium at Attachment H.*

The summary tables also include a recommendation on the use of each action, which weighs up the risks and benefits presented. If the Menu of Actions recommends that an action as a whole should not be used, it has not been included in the Guide to Implementation. These tables are not intended to be prescriptive, but to support evidence-based decision making, acting as a reminder to preserve previous experience and incorporate available research for consideration against the current environment.

4.2.8.2 Guide to Implementation

The Guide to Implementation shows which measures from the Menu of Actions are relevant for each stage of the AHMPPI (see Attachment F). These recommendations would need to be considered against the specific characteristics and circumstances of the current virus.

At the Targeted Action stage, when more information about the pandemic will be available, the Guide to Implementation also considers the appropriateness of each measure to different levels of pandemic impact.

5 Implementation

This chapter identifies the recommended approach to managing an influenza pandemic in the four emergency management areas of:

- **P**revention;
- **P**reparedness;
- **R**esponse; and
- **R**ecovery.

It also outlines the measures which could be implemented in each of the **R**esponse stages:

- Standby;
- Initial and Targeted Action; and
- Standdown.

Prevention	
Preparedness	
Response	Standby
	Action
	Standdown
Recovery	

Additional detail to support implementation at an operational level is provided in the Operational Plan at Part 2 of the AHMPPI.

Across all activities the **Strategic Objectives** will be to:

- Minimise transmissibility, morbidity and mortality;
- Minimise the burden on/ support health systems; and
- Inform, engage and empower the public.

5.1 Prevention Activities

Close collaboration with the animal health sector will be an important strategy in pre-pandemic surveillance—where a potential pandemic strain is circulating in animals. Animal disease prevention and surveillance programs are already in place in Australia. Close collaboration with regional neighbours in which the emergence of pandemic strains is more likely, through surveillance systems and early response to clusters of influenza viruses with pandemic potential are also key strategies.

As the nature of the influenza virus makes it difficult to control the transmission of this disease, it is unlikely it will be possible to prevent its entry into Australia once a pandemic is spreading globally. Unlike many other diseases, a comparatively high proportion of individuals will be asymptomatic but contagious, and therefore spreading influenza before it is possible to identify them. It will be difficult to detect as symptoms will be similar to many other common illnesses and without laboratory testing it will be difficult to confidently differentiate it from other diseases.

Implementation of an early and efficient response will be the key strategy for minimising transmission, morbidity and mortality within the community. To ensure the response is mobilised as quickly as possible, surveillance systems will routinely monitor emerging diseases.

5.2 Preparedness Activities

An influenza pandemic represents a significant risk to Australia. It has the potential to cause high levels of morbidity and mortality and to disrupt our community socially and economically. To mitigate this risk, the health sector will maintain an ongoing state of preparedness to respond to a pandemic.

Preparedness activities will focus on:

- establishing pre-agreed arrangements by developing and maintaining **plans**;
- **ensuring resources are available** and ready for rapid response;
- **researching** pandemic specific influenza management strategies; and
- **monitoring and investigating the emergence** of diseases with pandemic potential.

To be best prepared to respond rapidly and in a coordinated manner there should be broad agreement of arrangements in advance of a pandemic. This plan establishes these arrangements at a national health sector level. To develop and maintain preparedness to implement these arrangements, this plan will be regularly exercised and reviewed. At a jurisdictional level it will be important to support this by working with healthcare providers and communities to develop an understanding of arrangements and the capacity to implement them.

A key preparedness strategy will be to use existing systems wherever possible to implement the response, rather than creating pandemic specific procedures. This will allow them to be applied rapidly and efficiently. Familiarity with systems will also foster greater speed and confidence of use and minimise the need for specific

training. As capacity is built and refined in these systems through regular use, preparedness to respond to a pandemic will also be strengthened.

Research into alternative control strategies which may need to be employed to cope with the unique needs of a pandemic will be conducted as part of **Preparedness**, to determine the methods most likely to be effective. This research will be used to update plans and arrangements.

Individual agencies will be responsible for their preparedness to take part in the response. For key stakeholders it will be important to reflect this in preparedness plans. Of these roles and responsibilities, one of the most important **Preparedness** activities will be surveillance. Routine monitoring for the emergence of diseases of concern will occur through existing systems and continue throughout this stage. Should a disease of concern be identified a second tier of activities will commence to investigate the level of risk to the Australian community and determine whether arrangements will need to be escalated.

At the end of a pandemic, activities will be returned to preparedness, where they will continue in readiness for the next outbreak.

There is a strong relationship between **Preparedness** and **Response** activities. Some activities undertaken through existing ongoing preparedness systems, such as surveillance system identification and characterisation of the likely level of impact, are also the beginning of the response.

Activities which could be considered for the **Preparedness** Stage are outlined in the Operational Plan at Part 2 of the AHMPPI.

5.3 Response Activities

5.3.1 Standby Stage

There are a number of potential **triggers** for moving from **Preparedness** to **Standby** including:

- advice received under Surveillance Plan activities of an outbreak overseas of sustained community transmission of a novel virus; or
- a warning of a potential influenza pandemic received from WHO; or
- indications received from a jurisdiction that they may seek assistance under the AHMPPI to manage severe seasonal influenza; or
- an indication from CDNA of a trend in seasonal influenza which may overwhelm state and territory health systems.

The Standby stage may vary considerably in **duration** (an hour, weeks, months) depending on the progress of the pandemic. It is also possible that this stage may be skipped entirely, if progress moves rapidly into triggers for the Initial or Targeted Action stage.

Standby activities will focus on:

- **preparing** to commence **enhanced arrangements**;
- **identifying** and characterising the nature of the disease (commenced in **Preparedness**);
- communications measures to **raise awareness** and **confirm governance** arrangements; and
- **border** activities.

Most people will associate the Standby stage with the **preparations** to commence enhanced arrangements, such as checking stockpiles, pre-deploying items, planning use of resources and establishing essential priorities, which will be made by responsible agencies in order to be ready to mount a prompt response. However, Standby is not solely about preparations, and in the areas of disease characterisation, communications and border activities, it may be appropriate at this time to commence actively implementing measures.

It will be essential during Standby to continue the **identification and characterisation of the disease** commenced in the **Preparedness** stage, as a good understanding of the disease will help us to tailor our activities and increase their effectiveness. Activities in this area will continue in a pre-agreed manner described in the Surveillance Plan.

Communications measures should be commenced in order to mobilise responders and health services, and prepare the public for the impact of the disease, how it will be managed and how they can contribute to the response. Targeting of communication measures to vulnerable groups should be considered. More information about this is available in the Communications Chapter.

In the area of **border measures**, a decision will need to be made about whether to implement measures, and if so, which measures are appropriate to the current situation. The decision making process may include consultation with CHBOs and border agencies. If they are to be implemented with the goal of minimising transmission, they would need to commence during Standby to be most effective (as at this stage they could identify and manage the entry of individuals into Australia when community transmission here is still low.) A brief description of border measures is provided in the Menu of Actions.

Activities which could be considered for the Standby Stage are outlined in the Operational Plan at Part 2 of the AHMPPI.

5.3.2 Initial Action stage

There are a number of potential **triggers** for moving from **Standby** to **Initial Action** including:

- advice under Surveillance plan activities that the first case has been detected in Australia; or
- advice received under Surveillance Plan activities that there is sustained community transmission of a novel influenza virus which has emerged in Australia; or
- a declaration by WHO of an influenza pandemic; or
- a request for assistance with seasonal influenza from a jurisdiction.

Initial activities will focus on:

- **preparing and supporting health system needs;**
- **managing initial cases;**
- **identifying** and characterising the nature of the disease within the Australian context;
- providing **information to support best practice health care** and to **empower the community and responders** to manage their own risk of exposure; and
- supporting effective **governance**.

By definition, a novel virus, which is the most likely cause of a pandemic, would be associated with a relative lack of immunity within communities. Though the transmissibility of the disease will be a limiting factor, the combination of this lack of immunity with the rapid movement possible through modern international transport systems make it likely that once a novel influenza virus achieves efficient human to human transmission, it will spread across the globe and enter the Australian population quite rapidly.

Many of the measures which can be applied in response to a pandemic must be implemented early to be most effective. Therefore once there is sustained transmission of the pandemic disease within the Australian community, it will be important to commence measures as quickly as possible, even though, due to the novel nature of the virus, it is unlikely that we will yet have a good understanding of the epidemiology, clinical severity and virology of the disease.

Though information will initially be scarce, some predictions of the course of the disease and the demands it may make on our health systems and wider society can be made in comparison with seasonal influenza and past pandemics. Using this information a list has been developed (see the Operational Plan) of measures which would be likely to effectively meet the objectives of the AHMPPI in the absence of detailed knowledge of the disease.

As all pandemics are different, at the time of implementation, the appropriateness of these recommended measures should be examined in the light of what is known of the current pandemic virus, the vulnerability of the Australian population (particularly at-risk groups), and the current resource constraints. To support and maintain health system capacity, consideration of measures to protect the healthcare workforce will be of key importance.

5.3.2.1 Proportionate response: Initial measures

When initial measures are commenced, the likely lack of information about the disease will make it difficult to predict the level of impact. Evidence from overseas will give some indication, however this will not take into account the Australian context, and international reports of epidemiology, clinical severity and virology of the disease from overseas may be unreliable.

As the potential consequences of initially implementing measures aimed too low are more significant, the initial measures recommended below should be implemented at a level appropriate for a disease of moderately high impact. Measures will then be scaled up or down as more information becomes known. By reviewing measures regularly and early the consequences of aiming too high will be mitigated.

The risk of aiming at a pandemic of low impact and needing to scale up is that:

- the opportunity to manage the spread of the disease is lost; and
- death or severe morbidity (especially in at-risk groups) may be greater (as measures to reduce transmission, reduce clinical severity and raise awareness of symptoms by healthcare workers and the general public have not been fully employed).

The risk of aiming at a pandemic of high impact and needing to scale down is that:

- resources may be wasted (used without much gain, or diverted to pandemic activities where they could have been better used elsewhere);
- undue stress and concern may be imposed on Healthcare workers and the community; and
- perception of having over-reacted may make stakeholders less willing to participate in future.

Activities which could be considered for the Initial Action Stage are outlined in the Operational Plan at Part 2 of the AHMPPI.

5.3.2.2 Pandemic Vaccination

The most effective way of preventing infection with an influenza virus is vaccination. Access to immunisation is one of the main goals of the pandemic response.

By definition a pandemic will be caused by a novel virus, so it is likely to be some time before a customised vaccine, that is one based on the actual pandemic virus, becomes available. This could be up to six months. To ensure that a new customised vaccine can be accessed as quickly as possible if required, the Australian Government maintains contracts with vaccine manufacturers for their rapid development and supply.

Prior to the availability of a customised pandemic vaccine it may be appropriate to consider use of a candidate pandemic vaccine if one is available. Candidate vaccines may be developed and potentially stockpiled prior to a pandemic as a precautionary measure. They are based on a strain of influenza virus considered to have pandemic potential. Their effectiveness will depend on the similarity between the strain used to develop the vaccine and the strain causing the pandemic. They are most likely to be of value in protecting people at risk of complications from influenza and in protecting the health workforce in order to maintain the capacity of the health system (see Menu of Actions: Pharmaceutical measures for more information).

The early availability and uptake of vaccinations for seasonal influenza means that the capacity to manage the impact of seasonal influenza is likely to be greater than that for a pandemic. Uptake of immunisation programs, the efficacy of the vaccine and health system capacity may limit the effectiveness of both seasonal and pandemic programs. Cost may also influence uptake for families. Even though a customised vaccine is usually available early for seasonal influenza, a severe influenza season may still overwhelm health systems, where there are either large numbers of people with influenza, or large numbers of hospitalisations.

Australia's National Immunisation Program supports access to seasonal influenza vaccines and fosters safety and efficacy. Pandemic vaccination campaigns will build on these seasonal immunisation systems and the community attitudes established under these programs.

5.3.2.3 Planning Assumptions

The assumptions about the likely epidemiology, clinical severity and virology of the disease which underpin selection of these measures are provided in the Planning Assumptions Evidence Summary.

The following assumptions have also been made about the anticipated effect of the pandemic:

- lack of herd immunity (widespread community immunity) will cause elevated numbers presenting to some level of medical assistance;
- existing arrangements will therefore need to be augmented to cope with the changed and extended demands (this is a pre-requisite for the use of the AHMPPI);
- increased pressure will occur across the spectrum of health services, including hospitals, GPs, pharmacies/pharmacists, ambulance services, health air transport services, ACCHSs, nurse practitioners, Primary Health Networks and Residential Aged Care Facilities (RACF);
- the initial drive to identify cases will put pressure on laboratory capacity;
- at-risk groups (including vulnerable populations) will experience higher morbidity and mortality.

*From 1 July 2015 Primary Health Networks will replace and build upon the work of Medicare Locals.

5.3.3 Targeted Action stage

The Targeted Action stage will commence when there is sufficient information collected during the Initial Measures stage to inform refinement of the pandemic response measures already implemented. Measures will be regularly reviewed as more information becomes available.

Data on the clinical severity, transmissibility, epidemiology and antiviral resistance pattern of the virus will inform decisions on effective and proportionate pandemic response measures. CDNA/PHLN will provide advice to AHPPC on which individual measures should be:

- continued;
- modified (including scaled up or down);
- wound down and ceased.

CDNA/PHLN will also provide a recommendation of any new measures which should be commenced. Where measures are to be ceased, an exit strategy will be included. (The process and tools to support making these recommendations are described in the Decision Making section of the Governance Chapter.)

Targeted measures will focus on:

- supporting and maintaining **quality care**;
- ensuring a **proportionate response**;
- communications to **engage, empower and build confidence in the community**; and
- providing a **coordinated and consistent approach**.

The **flexible** approach of the AHMPPI means Targeted Action measures need not be adopted by all jurisdictions concurrently. Similarly, measures may be implemented differently within different geographic regions of jurisdictions. Each jurisdiction will consider the recommendations made by CDNA/PHLN and select measures which meet their own requirements, reflecting the differing progress of the pandemic, resource parameters and community needs in their jurisdiction.

As the pandemic becomes more widespread and the demands on resources increase, close tailoring of the selection of response measures to current needs and regular review of their effectiveness in contributing to the strategic objectives will be essential to promote the **efficient use of available resources**. Measures that fail to demonstrate this will be ceased.

Assessments of effectiveness will be based on available research, and on feedback from health sector stakeholders and the public (see Communications chapter). Review will be considered at key milestones, as noted in the Decision Support Map at Attachment D, or as indicated by feedback received.

Identification measures will move to collecting core data from established surveillance systems in order to detect any changes in the epidemiology of those getting sick, the clinical severity of the disease or characteristics of the virus. Jurisdictions will continue to collect enhanced data on up to 10 cases per week and for outbreaks in new settings.

Communications measures will continue to be important, following the same approach as outlined in the Initial Action section above. Key messages should be timely and consistent and reviewed regularly to ensure they reflect current information about the response, the disease itself and recommended management strategies (both for responders and the public) (see Communications Chapter for more detail).

Activities which could be considered for the Targeted Action Stage are outlined in the Operational Plan at Part 2 of the AHMPPI.

5.3.3.1 Proportionate response: Targeted measures

Regularly **reviewing** measures **and tailoring** their use during this stage as more becomes known about the disease in the Australian context will allow measures to be adjusted to be more **appropriate to the level of risk**. It will also be possible and important to better tailor measures to the specific needs of our most vulnerable populations.

As Initial measures are aimed at responding to a pandemic with a moderately high impact level, tailoring of measures in the Targeted Action stage is likely to involve scaling back.

5.3.4 Standdown Stage

Individual activities will be regularly assessed and stood down when they no longer contribute to the AHMPPI's goals. The **trigger** for the AHMPPI as a whole to move into the Standdown stage will occur when advice from CDNA indicates that the pandemic has reached a level where it can be managed under seasonal influenza arrangements. As the risk and impact experienced will not be homogenous across Australia enhanced activities may need to continue longer with some vulnerable populations.

Standdown activities will focus on:

- supporting and maintaining **quality care**;
- **ceasing** activities that are no longer needed, and **transitioning** activities to seasonal or interim arrangements;
- monitoring for a **second wave** of the outbreak, or the development of antiviral resistance;
- communications activities to support the **return** from **pandemic to normal** business services; and
- **evaluating** systems and **revising** plans and procedures.

Enhanced arrangements place an additional burden on health systems and individuals and should be scaled back when no longer necessary. The purpose of the Standdown stage will be to manage the smooth withdrawal of enhanced arrangements and transition to seasonal systems and procedures.

Communications measures will be important to:

- reassure stakeholders that they will still have access to the support they need;
- shape awareness of the possibility of further outbreaks and the continuity into the following two to three years of seasonal influenza; and
- ensure that the public understand the virus is still circulating and that they therefore need to continue to be aware of measures to protect themselves at an individual level.

The evaluation of the response, and updating of/adaptation of systems, which is part of this stage ensures that as much as possible, the lessons from the pandemic can be applied to future outbreaks. As subsequent waves of the pandemic are likely, rapid implementation of evaluation processes is essential to preparedness.

It is likely that the health sector will continue to require support to enable services to “catch up”. The community may also require additional services to enable full psychological, social, economic, environmental and physical recovery from the effects of the pandemic. At-risk groups may need additional support.

At some point the Department of Health will advise AHPPC that all enhanced measures have been transitioned to seasonal arrangements. While acknowledging that **R**ecovery activities will be taking place within the health sector, this will be the **t**rigger for AHPPC to consider returning the AHMPPI to the **P**reparedness stage, in which preparedness and monitoring activities will be ongoing until there is again a need to respond to a pandemic.

Activities which could be considered for the Standdown Stage are outlined in the Operational Plan at Part 2 of the AHMPPI.

5.4 Recovery Activities

Wherever possible during the pandemic, response activities will be selected and implemented in a manner most likely to promote robust recovery. Some communities and systems may be able to commence **R**ecovery activities sooner than others.

The primary responsibility for managing the recovery process within the health sector will rest with state and territory governments. National coordination and support required during this stage will occur through existing emergency management channels.

The Australian Government Disaster Recovery Committee, chaired by the Attorney-General’s Department will coordinate **R**ecovery efforts at a whole of government level. Governments will work together with affected individuals, community groups and industry to restore services and community wellbeing.

5.5 Resilience

Building preparedness within Australia’s health systems will contribute to the resilience and sustainability of our systems. The resilience of individuals will be promoted by empowering them to manage their own exposure to the disease through public messaging about:

- the status of the disease in Australia and internationally;
- hygiene and cough/sneeze etiquette;
- disease transmission;
- understanding of how to recognise the signs and symptoms of the disease and when to seek medical assistance; and
- access to support and advice, including mental health services.

To build resilience within our most vulnerable populations, communications within the health sector will be used to raise awareness of at-risk groups and their associated needs. Measures will also be implemented with consideration of necessary adaptations to meet the needs of these individuals and communities. The needs and challenges of communicating with low socio-economic communities, which may have reduced access to healthcare, will also be considered.

5.6 Emergence of the novel virus first in Australia

Though this plan focuses on activities in response to the emergence of a novel virus with pandemic potential overseas, it may also be applied should the novel virus emerge first in Australia. Variations to the plan would be required in the following areas:

Escalation:

- The timing of the **stages** may vary, as the pattern of community transmission may be different;

Implementation:

- If we are able to detect the new virus early, we may have more control over the application of measures to reduce transmission than if the disease is already circulating overseas. However, if it is not detected early, wide dispersion through the community may occur before we are able to put in place measures to reduce transmission and to protect at-risk groups;
- At our **international borders**, the emphasis will no longer be on managing incoming travellers, as a population with a higher risk of transmitting the disease. Instead we will be informing incoming travellers (including returning Australians) of the increased risk within Australia and helping them to integrate into our health system;
- We may be asked by the international community to implement **exit screening** measures. Though the effectiveness of such measures is not strong, decision makers will need to take into account the level of spread within our community and the likelihood that the disease has already spread outside Australia (if spread within Australia is still low it is more likely to be possible to limit the exit of the disease);

Communications:

- **Reporting to the international community**, in particular our reporting under the IHR and ongoing liaison with the WHO, will be both important and high profile;
- There will be great **demand from the international media** for reports about the Australian situation;
- The level of **uncertainty** around the information we share and use for planning may also be greater, as the early information from overseas will not be available. This should be openly acknowledged and regular revision of information provided as it becomes available;

Surveillance:

- Once the presence of a novel virus is identified there will be **pressure** on surveillance, domestically and internationally, to determine the existing spread and the characteristics of the disease. It may be necessary to prioritise allocation of resources in this area;

- Enhancement of surveillance systems would occur early. National coordination may be required to coordinate early data collection, analysis, reporting and **interpretation** so that disease characteristics can be identified as quickly as possible; and
- It is likely that the novel virus would be identified when an unidentifiable subtype emerged in routine testing. This sample would be forwarded to the World Health Organization Collaborating Centre for Reference and Research on Influenza (WHOCC), which would determine whether a novel virus had emerged. Investigation would also need to establish whether transmission occurred in Australia.

5.7 Application to seasonal influenza

In many ways the response to seasonal influenza and a pandemic would be the same, as wherever possible the AHMPPI uses existing arrangements. The key difference will be the capacity of a pandemic to overwhelm normal arrangements and the requirement to enhance our systems and approaches to cope with the increased demand.

When an outbreak of seasonal influenza is particularly severe, it has the capacity to overwhelm our normal systems in a similar way. It may therefore be appropriate to apply some of the measures or approaches in this plan. These are not unique, however the AHMPPI potentially provides:

- an agreed approach to mobilising, reallocating and coordinating resources at a national level;
- analysis of a range of options to reduce transmission, morbidity and mortality; and
- a method of communicating a consistent message, building trust and confidence when there may be public concern.

As the measures and approaches used in this plan are intended to be used flexibly, they can easily be used independently to address specific gaps in a response to severe seasonal influenza. Measures would be applied as though in the Targeted Action stage, as once awareness has developed of the presence of a severe influenza season, it is likely enough will be known about the epidemiology, clinical severity and transmissibility of the disease to target measures to specific needs.

6 Communications

This chapter provides a guide to communications activities across stakeholders.

Sharing information between those managing the response will enable the coordination of resources, better inform decision makers and provide access to expert guidance on the application of response measures.

Communication with the public, through the media and other sources, will shape the public perception of risk and the way in which the public is engaged in measures to address the pandemic.

A comprehensive communications strategy, implemented across all stages of the pandemic, is a key component of a successful response to an influenza pandemic. As the presentation of a pandemic in Australia will inevitably be complex and varied it will be a priority to put in place arrangements to support a consistent, informative message. The communications strategy described in this chapter is designed to reach the broad range of stakeholders involved in and affected by a pandemic, from health authorities and the medical profession, to the public and the media.

6.1 Key Principles

The following key principles will be applied across all our communications activities:

- openness and transparency;
- accurate risk communication, including where there is uncertainty;
- communications as a two-way process;
- use of existing communication channels and protocols, where possible;
- consistent, clear messages;
- regular, timely provision of tailored information;
- early release of public messages;
- timely response to queries;
- use of social media where appropriate;
- use of specific communication methods to facilitate communication with vulnerable populations;
- flexible selection of methods appropriate to the situation at the time; and
- use of a wide range of communications methods to reach a broad audience.

It should be noted that, while this chapter makes reference to communication activities in different stages of the pandemic response, it is the goal of the AHMPPI to maintain and enhance flexibility. Items from different stages may therefore be used concurrently or non-sequentially as their purpose demands.

6.2 Information gathering

Information about influenza viruses in Australia and in other countries is collected routinely every year by the Australian Government and State and Territory Governments. Sources of such information may include seasonal influenza surveillance systems, Australian embassies, other governments, Australian international disease experts and the WHO, which provides information about influenza viruses, or other viruses with pandemic potential, through communication systems such as the WHO Event Information Site.

As agreed under the IHR, Australia reports to the WHO any event of potential international public health concern, including specifically if there is a case of human influenza caused by an unusual subtype or where there is the potential for serious health impact.

The information gathered from these sources is used to advise Australians who may be travelling abroad, those considering overseas travel, and to inform surveillance and control of the disease in Australia. Should a disease which has the potential to cause a pandemic be detected, disease information will be shared with stakeholders.

During the pandemic, information will also be gathered about the health sector itself, such as current health service capacity; whether the management of acutely unwell people with influenza has meant that other routine services have been ceased temporarily; and absenteeism among HCWs and/or support staff due to illness, caring for family or fear of infection, where possible. The information gathered will be critical to informing decisions about pandemic response measures and for prioritising health services locally and at the state and national levels.

6.3 Sharing information between those involved in managing the response

Audience: This section is aimed at communication between Australian Government agencies, state and territory government agencies and other key stakeholders involved in providing a health sector response to an influenza pandemic.

Purpose: To support coordination of resources, better inform decision makers and provide access to expert guidance on the application of response measures.

Aims:

Preparedness	<ul style="list-style-type: none">• Build a clear understanding by the parties that will be involved in a pandemic response of<ul style="list-style-type: none">- roles and responsibilities; and- mechanisms for communications and governance;• ensure key responders are aware of the emergence of novel influenza viruses with pandemic potential, and any plans for responding;• build an understanding that there will be uncertainty and a need for flexibility (over time and geographically);• prepare HCWs to be conduits for information to the public;• ask responders to be prepared to participate in early data collection and to provide feedback throughout the pandemic response;• obtain buy-in for major strategies.
Standby	<ul style="list-style-type: none">• Ensure responders are aware of available information about the epidemiology, virology and clinical severity of the disease (and the level of uncertainty associated with the information). This will allow responders to prepare resources and strategies for<ul style="list-style-type: none">- treatment;- managing staff;- allocating resources; and- communicating and coordinating with other responders and patients.• ensure responders are aware of information about the progress of the pandemic overseas. This will allow them to consider planning aspects related to scale and timing;• responders to ensure they understand their role, they are connected to communications networks and plans are finalised; and• build trust and confidence.

Action (Initial & Targeted)	<ul style="list-style-type: none"> • Build awareness across the health sector of the most up-to-date and accurate information about the disease, to support effective diagnosis and treatment, and better informed management decisions; • promote a consistent approach by ensuring all key parties have the same information, though recognising that disease spread may be variable across the country; • support best practice by disseminating guidance in key areas developed by expert bodies, such as CDNA/PHLN; • share effective strategies, avoiding the need for them to be developed separately by all parties; • input feedback on the effectiveness of treatment options, side effects and other clinical/ public health information into decision making processes to support refining the approach; • input feedback on how well the health care system is coping; and • maintain trust and confidence.
Standdown	<ul style="list-style-type: none"> • Continue to support awareness of the most up-to-date and accurate information about the disease, to support more effective diagnosis and treatment, and better informed management decisions; and • clarify arrangements for transitioning to normal business.

6.3.1 Challenges:

- Sharing information in a timely manner;
- ensuring people are getting access to the information they need;
- ensuring a consistent message across media and authorities;
- consistent messaging within a flexible response where the response strategies are at different stages across the country;
- communication of initial decisions even though information about the virus may be sparse and/or unreliable;
- communication of the uncertainty of what the impact of the pandemic will be;
- initial information may be based on the behaviour of the disease in another country and not 100% relevant to the Australian context; and
- making sense of feedback, consolidating this and incorporating it into messaging.

6.3.2 Australian Government and state and territory governments

The Australian Government and state and territory governments will share information, via existing channels, about:

- the situation overseas;
- advice from international bodies, such as the WHO;
- the status and impact of the pandemic in Australia;
- the epidemiology, severity and virology of the disease; the implementation and impact of measures to manage the response to the pandemic; and
- deployment of the NMS.

Communication between Australian Government agencies relevant to the response will be coordinated by the Department of Health. Communication between relevant state and territory government agencies will be coordinated by state and territory health departments.

Cross government linkages are also supported by representation on the NCC, which would be convened by the Australian Government in the event of an influenza pandemic.

Specific information on the status of the pandemic and key response documents will be posted on the Department of Health homepage (www.health.gov.au).

6.3.3 National Incident Room

The Department of Health's NIR provides a point of communication with the Australian Government for health incidents.

During the Standby, Initial Action, Targeted Action and Standdown stages the NIR will provide timely situation reports to relevant Australian Government agencies, state and territory health authorities and other relevant stakeholders.

6.3.4 Other key health stakeholders (healthcare workers, health and social service providers)

Healthcare workers and providers need access to timely, accurate and comprehensive clinical information and advice in order to effectively manage patients; implement pandemic control measures and minimise their own risk of exposure. Such advice will be provided by CDNA and other clinical groups as appropriate and endorsed by AHPPC.

National communication with healthcare workers will primarily be through existing channels via their relevant peak body. Peak body websites will be particularly important vehicles for disseminating information. Additionally, S/T HD will consolidate communication with healthcare workers and providers (both government and non-government, such as private hospitals) and include state and local level information via their own communication channels. Communication may either target clinical and/or administrative aspects of health services, according to the nature of the information to be delivered.

Coordination of pandemic plans occurs in the Preparedness stage and will continue throughout the Standby, Initial and Targeted Action and Standdown stages.

Pandemic planning support and advice is available for GPs and other primary health care providers in: *Managing Emergencies and Pandemics in General Practice: a guide for Preparation, Response and Recovery*. (www.racgp.org.au/your-practice/guidelines/flukit).

Information from health service providers to the Department of Health and S/T HD about the impact of the pandemic on their service capacity is essential to inform pandemic response decision making. These perceptions and experiences will be input into decision making processes via surveys, consultation with peak bodies and broader consultative forums.

6.3.5 Information materials to support responders

Attachment C contains two documents. The first is a template which can be used to support high level decision makers (such as AHPPC) in the development of consistent, comprehensive messages (for either responders or the public). It is based on the WHO description of best practice for communicating with the public during an outbreak.

The second is a table exploring methods of sharing information with stakeholders.

6.4 Public communications

Audience: This section considers communication by governments with the general public, businesses, the non-government sector, industry groups, and a range of other relevant stakeholders and audiences.

Purpose: To provide information to the public to inform their understanding of the risk, engage them effectively in public health measures and guide their own management of their exposure to risk.

As the key communication channels to the public are via television, radio, print, online and social media outlets, effective media engagement strategies will be required to ensure the key public messages are conveyed to the public.

Aims:

Preparedness	<ul style="list-style-type: none"> • Improve awareness of potential health/societal implications of pandemic influenza, and what this could mean for individuals, the community and economy; • influence attitudes, minimise misconceptions, encourage positive behaviours especially, in line with seasonal influenza (e.g. respiratory hygiene, vaccination for at-risk groups); and • shape expectations of a pandemic (including uncertainty at the beginning), what individuals can do to prepare themselves and their households and the government role.
Standby	<ul style="list-style-type: none"> • Empower individuals and build public confidence by keeping people informed of the current situation; what is being done to address it; and what individuals can do to minimise their risk and to prepare themselves for the potential societal impacts; • encourage behaviours and attitudes that will contribute positively to reducing the spread of disease and minimise the psychological, social and economic impacts including the need to assist others in the community; • shape public expectations of governments' response activities; and • provide information to inform decisions about travel.

Initial & Targeted Action	<ul style="list-style-type: none"> • Build and maintain public trust and support by providing consistent, clear, informative public messaging; • encourage behaviours and attitudes that will contribute positively to reducing the spread of disease and minimise the psychological, social and economic impacts including assisting others (neighbours, family, friends etc.); • manage the disease threat by increasing uptake of recommended actions; • build public confidence by keeping people informed of the current situation and what is being done to address the impact of the pandemic; and • empower individuals by increasing their understanding of the seriousness of the disease; knowledge of what to do to avoid/minimise exposure; ability to recognise symptoms and knowledge of what to do if symptoms present. • ensure individuals, communities and specific stakeholders understand the reasons why interventions might be modified and tailored to best meet the needs of the situation and/or specific population groups; • support essential services; and • provide information to at-risk groups.
Standdown	<ul style="list-style-type: none"> • Support transition to business as usual services; and • shape expectations of services and circumstances, such as the possibility of further outbreaks and the continuity into the following two to three years of seasonal influenza.

6.4.1 Challenges

- Public concern may be high;
- experience of the 2009 milder pandemic may lead to apathy in some;
- scientific knowledge will be limited at the beginning of the pandemic, uncertainty will be high;
- early decisions concerning measures may rely in part on planning assumptions;
- communication of planning assumptions may be seen as a prediction of what will happen;
- balancing early release of public messages with accuracy of information;
- balancing public release of information with privacy/confidentiality for those involved;
- accurate communication of risk in a situation of uncertainty that is rapidly changing;
- consistent messaging within a flexible response where the response strategies are at different stages across the country;
- coordination and consistency of messaging where there are multiple spokespeople;
- ensuring two-way communication;
- meeting media requests in time to meet the needs of 24 hour news media; and
- media outlets are commercial agencies and their prime purpose is not necessarily to provide consistent public health information.

Public communication provides an opportunity both to address any public concern caused by the pandemic and to engage the public in strategies to manage the impact of the disease. The dissemination of up to date, consistent and accurate information about the status of the disease overseas and in Australia can help people understand the real risk and make more informed decisions about work and travel, taking up health recommendations and planning for people in at-risk groups. Information about the implementation of activities and arrangements can build public confidence in the capacity of health services to manage the response.

Providing the public with information about the nature of the disease can empower individuals to take steps to reduce the risk to themselves and their families. This will both alleviate concern and lead to more appropriate use of recommended measures. Increasing rapid presentation of appropriate cases to a medical practitioner will lead to reduced morbidity and mortality. Reducing presentation of the 'worried well' will decrease the burden on health systems. Information gathered from the public about concerns, issues with measures and information gaps is also important to inform decision making.

To take steps to manage their risk during an influenza pandemic people will need to:

- understand the seriousness of the disease;
- know what to do to avoid/minimise exposure;
- recognise symptoms; and
- know what to do if symptoms present.

6.4.2 Coordination: Developing a consistent message

A wide range of information will be available to the public should a pandemic occur. The Australian Government and State and Territory Governments will have to position themselves as authoritative sources from very early on in the pandemic. Enlisting the cooperation of key spokespeople in the non-government sector (e.g. university academics, the Australian Medical Association) will be important for building confidence in the response strategies.

A number of coordination mechanisms have been put in place to ensure consistency of public messaging. Guidelines and processes for the coordination of public information representing broad whole of government issues are outlined in the National CD Plan.

Key health sector pandemic messages and advice regarding requirements for changes of communication strategies to reflect the progress of the pandemic will primarily be determined by AHPPC. AHPPC will develop these messages using recommendations from CDNA, PHLN and other advisory bodies.

The dissemination of these messages and adaptation for specific audiences will be coordinated by NHEMRN. NHEMRN is made up of representatives of all Department of Health and S/T HD Media Units; relevant Australian Government agencies, national medical colleges and associations, the National Aboriginal Community Controlled Health Organisation (NACCHO) and select parts of the private sector directly involved in emergency health management. It is coordinated by the Media Unit of the Department of Health. Its role is to keep the public and the media informed during national health emergencies by providing consistent and coordinated media and public responses.

Communication regarding issues outside the health sector, such as school closures, will be managed by the NCC, as discussed in the Governance Chapter.

During a pandemic NHEMRN will:

- meet by teleconference daily to discuss public communication issues, including the approval of advertising and information materials;
- share information on media announcements, media releases and information sources;
- provide updates on current cases and deaths during the early stages of the pandemic;
- place current data within the context of seasonal influenza levels; and
- share information obtained from counterparts overseas, such as the WHO Communications Team and the United States of America's Centers for Disease Control and Prevention.

Messaging and strategies agreed at NHEMRN teleconferences will feed into the media communications that occur at state/territory level. The Media Unit within the NIR will be a further contact point for coordination with states and territories. Coordination of public communications within jurisdictions will be in accordance with jurisdictional arrangements.

Media communication regarding the Australian Government activities related to management of the pandemic will be coordinated by the Department of Health Media Unit, which will work with relevant Australian Government agencies to ensure a consistent, whole of government message.

6.4.3 Media engagement strategies

The media will be the main source of information for the public during a pandemic. Building strong relationships with media contacts is essential to foster positive representation of response efforts and accurate relay of public health messages.

Media contacts will be notified early in the pandemic of a 1800 media enquiry phone number managed by the NIR Media Unit, which will be available 24 hours a day, seven days a week. A shared email address will be established for quick response to media enquiries.

Key media engagement strategies that will be used in the various stages of the pandemic may include:

- during the **Preparedness** stage, consult with a representative media group to:
 - review the Australian Government Communications Strategy;
 - discuss media requirements;
 - negotiate and agree on availability of information during a health emergency such as daily updates at a specified time on cases and deaths; timing of regular press conferences; access to spokespeople; availability of web streaming, Twitter, Facebook, YouTube and web notifications; and
 - agree on arrangements for out of hours contact of key journalists.
- during standby stage review Media Unit staffing requirements and preparation of and agreement on likely key messages for media use;
- during the Initial Action and Targeted Action stages:
 - regularly update the Department of Health homepage (www.health.gov.au) with situational information, important health messages, updates of case numbers and deaths, media alerts, media releases, transcripts of media interviews, streaming of commercials, print resources, communications materials, questions and answers, information on relevant social media links etc.;
 - use the Department of Health's existing social media accounts (Facebook, Twitter and YouTube) to provide up to date notifications on health emergency media opportunities and pandemic information;

- make available appropriate spokespeople for media interview;
 - develop and disseminate via the Internet pre-recorded broadcast quality radio and TV grabs using existing media release audio mailbox; and
 - apply similar strategies within S/T HD.
- during stand down, provide advice to the media of the transition to normal media engagement arrangements.

To promote presentation of a consistent message between government statements and media commentary, information will be made available regularly to the media from government sources both at regular predictable intervals and upon request. Information tailored to key audiences will also be produced where priority needs are identified.

6.4.4 Spokespeople

A range of spokespeople will be available during the response to the pandemic, including all Health Ministers, the Chief Medical Officer, Chief Health Officers, media unit representatives and spokespeople identified at the local level.

The relevant spokesperson will depend on the stage of the pandemic and the aim of communications. When the focus of the message is related to events and activities in a specific jurisdiction, the spokesperson will be determined by that state/territory. When content is confined to Australian Government activities, the spokesperson will be identified by the NIR Media Unit. Where key groups are to be targeted, peak and representational bodies will be consulted, for example, NACCHO will assist in nominating appropriate spokespeople for Aboriginal and Torres Strait Islander communities.

Under the AGCMF, the Prime Minister may assume primary responsibility for leading the Government's response, including acting as primary Government spokesperson. Under these circumstances, the Prime Minister is also likely to consult with the leaders of affected states and territories to ensure a coordinated national response.

6.4.5 Ensuring two way communication

It is essential that public awareness and attitudes be monitored to inform refinement of public messaging. This is critical to achieving the right balance between motivating risk-mitigating behaviours by raising public awareness of potential risks, and reassurance that the situation is under control. It may be that different groups within the community are at opposite ends of this spectrum, and messages may then have to be targeted appropriately to manage this. Listening to the public also helps to identify community concerns, information gaps and misconceptions or misinformation, which can then be addressed within public communications. Communication with at-risk groups, such as Aboriginal and Torres Strait Islander or aged care communities, is particularly important to tailor measures to the needs of people with greater vulnerability.

Methods to gauge public awareness and attitudes that may be used include:

- market research during Preparedness and standby stages on knowledge and attitudes to a pandemic threat;
- comprehensive market research undertaken by the Department of Health at the outset and throughout the pandemic;
- feedback from peak bodies via usual communication channels in Preparedness and standby stages, such as the GP Roundtable, Clinical Stakeholders Forum, Aged Care providers' peak bodies, Primary Health Networks and NACCHO;
- monitoring of media sites by Media Units in NIR and S/T HD;
- monitoring of social media, including large, open social media sites;
- use of social media or an interactive health emergency website where members of the public can share content, comment and ask questions which will be answered online, based on an agreed "question and answer" formula; and
- feedback from a wide range of stakeholders regarding the impact and effectiveness of the pandemic response measures that have been undertaken obtained by the Department of Health and S/T HD.

6.4.6 Other communication methods

Information tailored to key audiences will be produced where priority needs are identified. Dissemination of this information will also be tailored to the specific audience, e.g. use of specialised Aboriginal and Torres Strait Islander media outlets to communicate key messages targeting people in remote Aboriginal and Torres Strait Islander communities.

Paid advertising may be used, particularly if there is a need to rapidly mobilise the community, such as for pandemic vaccination.

Print resources which can be distributed directly to stakeholders who interact with the public will also be used widely, including information for patients from HCWs; information for families distributed via schools; information for travellers made available at travel agencies and airports; information distributed through organisations associated with mass travel for specific purposes such as international sporting events and religious gatherings etc. Printed and electronic information may also be displayed at targeted places such as GP clinics, travel agencies and airports. Materials can also be made readily available for responders and the public at a centralised web location e.g. Australian Government and S/T HD websites.

Social media messages can be used to deliver key messages (e.g. disease information, behaviours to be promoted, situation changes) in a timely manner to responders and the public. Social media messages can be updated on a regular basis to ensure currency of information. The use of existing social media trending tags may be considered to maximise the reach of social media messages.

The Department of Health and the Australian Government Department of Foreign Affairs and Trade will work together to provide information for Australians considering overseas travel and for Australians overseas when considering whether to return home.

HCWs play an important role in explaining and reassuring their clients about the pandemic. Information provided to HCWs will include key messages for the public as well as provide greater detail about the rationale behind pandemic decisions to enable HCWs to appropriately counsel their clients.

6.4.7 Supporting at-risk groups

Communication will also be tailored to meet the needs ranging across our community, particularly those with a higher risk of complications from the disease. Support for mental health needs of vulnerable individuals and the community as a whole will also be considered. As important as tailoring of messages will be careful selection of channels of communication to ensure that messages are reaching as many groups across the population as possible. Engaging and supporting community leaders in relevant target groups will be a key strategy to promote implementation of desired practices and involvement in public health measures.

In the aged care sector the Department of Health will work closely with aged care providers. Aboriginal Medical Services and other services for Aboriginal and Torres Strait Islander peoples will support the needs of this vulnerable group. An Aboriginal and Torres Strait Islander clinical advisory group will be brought together and used to support communications to the Aboriginal and Torres Strait Islander community and to provide an avenue for feedback to inform decision making processes. The need for provision of advice in other languages, at the border, and domestically will also be considered. As infants are also likely to be a high risk group and a vector of disease, coordination with child care facilities is also important. Community outreach services, such as non-government organisations and churches will be used to support communication with vulnerable people who may not have access to mainstream health services.

6.4.8 Public Information Materials

The table at Attachment C gives detail on the information that will be provided to key stakeholders in the implementation of a pandemic response. The specific materials during the pandemic may vary, however all issues in the table will be covered.

The diagram below outlines the key communications channels used during pandemic preparedness and response activities.

Figure 7: Pandemic Preparedness and Response Communication Channels.

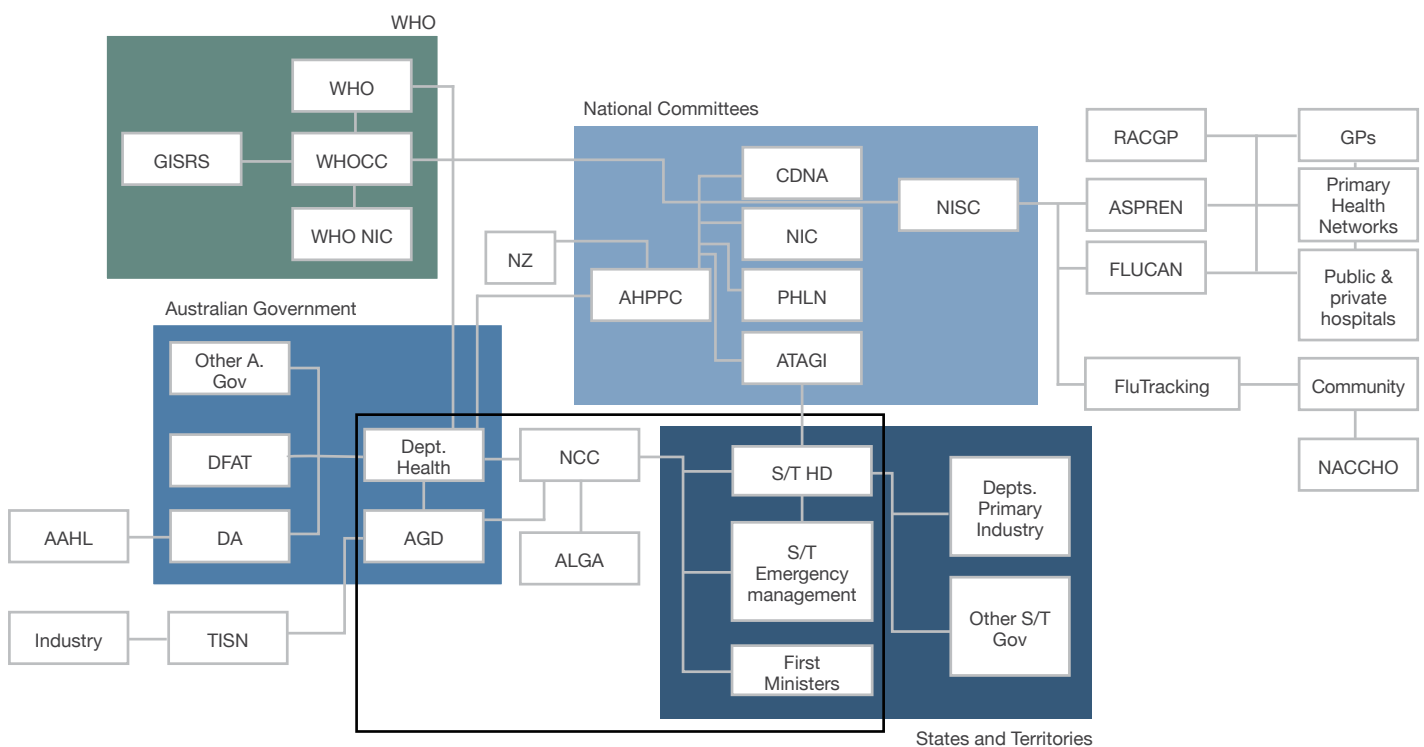

Pandemic Preparedness and Response Communication Channels Glossary

AAHL	Australian Animal Health Laboratory
AGD	Attorney General's Department
AHPPC	Australian Health Protection Principal Committee
ALGA	Australian Local Government Association
ASPREN	Australian Sentinel Practice Research Network
ATAGI	Australian Technical Advisory Group on Immunisation
CDNA	Communicable Diseases Network Australia
DA	Department of Agriculture
Dept. Health	Australian Government Department of Health
Depts. Primary Industry	State and territory departments of primary industry
DFAT	Department of Foreign Affairs and Trade
FLUCAN	The Influenza Complications Alert Network
FluTracking	FluTracking is an online health surveillance system to detect epidemics of influenza.
GISRS	Global Influenza Surveillance and Response System
GPs	General Practitioners
NACCHO	National Aboriginal Community Controlled Health Organisation
NCC	National Crisis Committee
NIC	National Immunisation Committee
NISC	National Influenza Surveillance Committee
NZ	New Zealand
Other A. Gov	Other Australian Government departments
PHLN	Public Health Laboratories Network
RACGP	Royal Australian College of General Practitioners
S/T	States and territories
S/T HD	State and territory health departments
TISN	Trusted Information Sharing Network

WHO	World Health Organization
WHO NIC	World Health Organization National Influenza Centres
WHOCC	World Health Organization Collaborating Centre

PART 2

Operational Plan

This Operational Plan provides additional detail to support the implementation of activities under the AHMPPI at an operational level. It relates particularly to the Implementation Chapter of the main body of the AHMPPI, in which an overview of the approach and priorities within each of the AHMPPI stages is provided. Information on the bodies responsible for undertaking these tasks is outlined in the Governance Table at Attachment I.

It can be used by planners prior to or during a pandemic as an operational checklist of activities.

Across all activities the **Strategic Objectives** will be to:

- Minimise transmissibility, morbidity and mortality;
- Minimise the burden on/ support health systems; and
- Inform, engage and empower the public.

Preparedness activities

Preparedness activities are conducted continuously, as part of business as usual operations, until there is a need to respond to a pandemic.

Preparedness activities will focus on:

- establishing pre-agreed arrangements by developing and maintaining **plans**;
- **researching** pandemic specific influenza management strategies;
- **ensuring resources are available** and ready for rapid response; and
- **monitoring the emergence** of diseases with pandemic potential, and **investigating** outbreaks if they occur.

The following **Preparedness** measures could be considered for implementation:

Planning

Influenza specific plans	<ul style="list-style-type: none">• Develop and maintain (including exercising) a whole of government (WoG) plan;• develop and maintain a national health sector plan;• develop and maintain jurisdictional plans; and• develop and maintain a national surveillance plan for pandemic influenza.
Broader planning	<ul style="list-style-type: none">• Ensure influenza pandemic arrangements can be incorporated into wider emergency plans and arrangements; and• incorporate planning for an influenza pandemic into overall business continuity plans.

Research

Pre-pandemic	<ul style="list-style-type: none"> • Commission and share research, including modelling, on the impact and effectiveness of public health measures which could be used to manage an influenza pandemic; • consider the effectiveness of antiviral drugs and candidate vaccines; and • commission and share research, such as population serosurveys to define susceptibility; improved diagnostic assays (such as point-of-care (POC) testing), markers of viral virulence and transmissibility, and better understanding of immune responses, particularly in relation to vaccines.
During a pandemic	<ul style="list-style-type: none"> • Develop a process for rapid, directed research funding, which can be used during a pandemic.

Ensuring resources are available and ready for rapid response

Resources (stockpile)	<ul style="list-style-type: none"> • Establish and maintain the NMS; • develop jurisdictional NMS distribution plans; • maintain awareness of current stockpile levels; and • regularly review deployment arrangements.
	<ul style="list-style-type: none"> • Implement measures to support strong supply chains; • maintain awareness of evidence of antiviral/ antibiotic resistance; and • determine state and territory delivery sites.
Resources (HR)	<ul style="list-style-type: none"> • Consider arrangements to ensure maintenance of human resource availability, particularly in highly skilled areas, such as ICU nursing.
Clinical care & Public health management	<ul style="list-style-type: none"> • Undertake seasonal influenza arrangements; • build the capacity in RACFs to manage outbreaks of influenza; and • sustain International Health Regulations (IHR) core capacities, including the National Focal Point (NFP).
Vaccination	<ul style="list-style-type: none"> • Implementation of seasonal influenza immunisation programs; • make arrangements with vaccine manufacturers to guarantee customised pandemic vaccine supply; • develop pandemic vaccine program delivery strategy; • develop communication strategies and resources for pandemic influenza immunisation; • assess immunogenicity and cross protection of candidate pandemic vaccines; and • purchase and store vaccination equipment (needles and syringes).
Infection control	<ul style="list-style-type: none"> • Establish and maintain infection control guidelines for healthcare, point of entry and aircraft/sea vessel environments; and • ensure the national system for monitoring adverse events following immunisation (AEFI) could rapidly incorporate monitoring of the pandemic vaccine.

Identification (see Surveillance Plan for more detail)

Routine Surveillance monitoring	<ul style="list-style-type: none"> Establish and maintain systems to collect influenza surveillance data; regularly monitor international data; undertake routine domestic surveillance; and liaise with animal surveillance sector.
Investigating outbreaks of diseases with pandemic potential	<p>If an outbreak occurs:</p> <ul style="list-style-type: none"> collate epidemiological, clinical severity and virological data on the outbreak from international sources; monitor for the emergence of the disease in Australia; develop case definitions; and identify at-risk groups.
Laboratory Capacity	<ul style="list-style-type: none"> Establish and maintain laboratory testing capacity/capability; and (if an outbreak occurs) develop and validate tests, establish quality assurance.

Communications (see Communications Chapter for more detail)

Sharing information between responders	<ul style="list-style-type: none"> Establish and maintain health sector communications processes; establish and maintain the NIR; (jurisdictions) communicate public health events of national significance to the NFP; share information broadly amongst the health sector on the emergence of influenza viruses with the pandemic potential; and liaise with international counterparts.
Public Communications	<ul style="list-style-type: none"> Provide advice to support management of seasonal influenza; provide the media with information regarding the government approach to emerging influenza viruses; make spokespeople available; and respond to media requests.

(Communication measures related directly to infection control and border are included in those sections.)

Border activities

Arrangements	<ul style="list-style-type: none"> Establish arrangements to provide pandemic border control and relevant health services by Australian Government border agencies and jurisdictional health departments; and appoint biosecurity officials and human biosecurity officers to implement arrangements; and develop and provide training and standard operating procedures for border workers to effectively implement border measures.
Communications	<ul style="list-style-type: none"> develop communication materials appropriate for use at the border and directly with travellers.

Governance

AHPPC	<ul style="list-style-type: none"> Establish governance arrangements for pandemic influenza and ensure they are consistent with broader emergency arrangements.
Legislation	<ul style="list-style-type: none"> Prepare and action any legislative instruments required to support actions.

Standby Stage

Triggers for moving from **Preparedness** to **Standby** include:

- advice received under Surveillance Plan activities of an outbreak overseas of sustained community transmission of a novel virus; or
- a warning of a potential influenza pandemic received from WHO; or
- indications received from a jurisdiction that they may seek assistance under the AHMPPI to manage severe seasonal influenza; or
- an indication from CDNA of a trend in seasonal influenza which may overwhelm state and territory health systems.

Standby activities will focus on:

- **preparing** to commence **enhanced arrangements**;
- **identifying** and characterising the nature of the disease (commenced in **Preparedness**);
- communications measures to **raise awareness** and **confirm governance** arrangements; and
- **border** activities.

In the Standby stage, the following measures could be considered for implementation:

Preparing to commence enhanced arrangements

Resources (stockpile)	<ul style="list-style-type: none"> • check the status of the NMS, jurisdictional stockpiles and other equipment (antivirals, antibiotics, PPE); • raise awareness of protocols for access to stockpiles during pandemic; • contact warehouses and transport companies to ensure readiness; • Australian Government and state and territory governments to liaise concerning stockpiles; • assess pre-deployment across states and territories and move stock from the NMS as appropriate; • confirm state and territory delivery sites related to NMS deployment; and • pre-deploy PPE to Border Agencies (if undertaking border measures; responsibility of the border agency).
Resources (HR)	<ul style="list-style-type: none"> • Consider human resource availability, particularly in highly skilled areas, such as ICU nursing;

<p>Clinical care & Public health management</p>	<ul style="list-style-type: none"> • Prepare arrangements for triaging in primary care; • prepare arrangements for cohorting of patients; • prepare arrangements for reducing in non-urgent work—primary and secondary care; • prepare arrangements for providing additional support to at-risk groups; • raise awareness of potential at-risk groups; • prepare contingency support for home based care; • hospitals <ul style="list-style-type: none"> - prepare to review elective procedures; - prepare for surge capacity in ICU beds/respiratory care beds; • prepare pre-hospital emergency care (ambulance and other medical transport); • prepare and raise awareness of pandemic protocols in RACFs; • emergency departments prepare for increased demand.
<p>Vaccination</p>	<ul style="list-style-type: none"> • Seek advice on appropriateness of candidate vaccine (if held) to current strain; • if appropriate, pre-deploy vaccine and available vaccination equipment; • consider commencing candidate vaccination. • examine existing Deeds for customised pandemic vaccine supply and consider activating; • determine priority groups for vaccination; • liaise with suppliers to ensure readiness to commence manufacture; • assess need to pre-deploy vaccination equipment (needles and syringes); and • refine pandemic vaccine program delivery strategy.
<p>Infection control</p>	<ul style="list-style-type: none"> • Provide advice on: <ul style="list-style-type: none"> - respiratory hygiene and hand-washing; - how to find out more information; and - hotline details (if any).

Identification

<p>Surveillance (see Surveillance Plan for more detail)</p>	<ul style="list-style-type: none"> • Continue to monitor international data; • undertake enhanced domestic surveillance; • activate case notification system; • review sustainability of surveillance systems; • prepare/ refine case definition as required; • prepare to conduct contact tracing; • confirm likely at-risk groups; • ensure readiness to commence First Few 100 study (FF100—see Surveillance plan for description); and • prepare additional studies (to be activated under established arrangements).
<p>Laboratory Capacity (HR)</p>	<ul style="list-style-type: none"> • Develop/ensure access to laboratory test capacity/capability.

Communications (see Communications Chapter for more detail)

<p>Sharing information between responders</p>	<ul style="list-style-type: none"> • Initiate contact between key stakeholders <ul style="list-style-type: none"> - share information on the status of disease spread; - confirm expectations; and - confirm communications and governance mechanisms. • share information broadly amongst the health sector on the status of disease spread and the current response; • bring together Aboriginal and Torres Strait Islander clinical advisory group to consider communications needs for this group; • prepare social media materials, particularly mobile phone and tablet based apps; • liaise with international counterparts; • provide public health management guidance; • provide clinical health management guidance (primary care and hospital based); and • confirm application of standard infection control strategies.
<p>Public Communications</p>	<ul style="list-style-type: none"> • Coordinate public messaging by convening the National Health Emergency Media Response Network (NHEMRN); • coordinate WoG public messaging; • provide information on the status of disease spread and the current response; • provide information to Australians concerning travel to at-risk areas; and • provide information to prepare at-risk groups. • monitor feedback and refine communications to address issues and concerns identified; • provide media with access to regular updates on the status of disease spread and the current response; • provide access to background information; • make spokespeople available; and • respond to media requests.

(Communication measures related directly to infection control and border are included in those sections.)

Border activities

<p>Communications</p>	<ul style="list-style-type: none"> • Distribute/display any disease specific communication materials at airports/seaports and through relevant channels (e.g. travel agents, travel doctors, tour companies, cruise lines); • confirm distribution instructions; • provide information to travellers through In-flight announcements; • implement signage (such as crawlers on customs screens, electronic displays or banners/posters); and • provide infection control guidance for points of entry and airlines/shipping lines.
<p>Liaison</p>	<ul style="list-style-type: none"> • Negotiate with airports/seaports/border agencies for placement of signage and printed materials; and • liaise with airline/airport & seaport/shipping industries to advise them of proposed border measures and enlist participation if required (e.g. assistance with distribution of materials, provision of announcements).

Governance

AHPPC	<ul style="list-style-type: none">• Consider enhanced border measures supported by advice from the Chief Medical Officer (as the DHB) and the CHBO forum;• identify key communications messages to raise awareness and confirm governance arrangements;• consider support for repatriation of Australians from overseas, if required; and• consider powers available under the <i>Biosecurity Act 2015</i> to support the pandemic response.
Legislation	<ul style="list-style-type: none">• Prepare and action any legislative instruments required to support actions.

Initial Action Stage

There are a number of potential **triggers** for moving from **Standby** to **Initial Action** including:

- advice under Surveillance plan activities that the first case has been detected in Australia; or
- advice received under Surveillance Plan activities that there is sustained community transmission of a novel influenza virus which has emerged in Australia; or
- a declaration by WHO of an influenza pandemic; or
- a request for assistance with seasonal influenza from a jurisdiction.

Initial activities will focus on:

- **preparing and supporting health system needs;**
- **managing initial cases;**
- **identifying** and characterising the nature of the disease within the Australian context;
- providing **information to support best practice health care** and to **empower the community and responders** to manage their own risk of exposure; and
- supporting effective **governance**.

In the Initial Action stage, the following measures could be considered for implementation:

Preparing and supporting initial Health System needs & managing initial cases

Resources (HR & stockpile)	<ul style="list-style-type: none">• Monitor health system capacity;• health system to prepare surge staff;• consider prioritisation of resources;• maintain the NIR (staff, equipment, management systems);• provide PPE, candidate pandemic vaccines and/or antiviral PrEP as appropriate (healthcare workers/ border workers);• organise delivery to points of use (states and territories);• deploy stockpile items from storage sites to State and Territory delivery sites ready for use;• consider needs for additional support to health systems in remote communities;• maintain essential health system activities.
----------------------------	--

<p>Vaccination</p>	<ul style="list-style-type: none"> • Refine pandemic specific immunisation program; • once virus is isolated, activate contracts for customised pandemic vaccine manufacturing and purchasing; • register customised pandemic vaccine, when available; • identify vulnerable groups to ensure access is available as early as possible; • if available, commence candidate vaccination to target groups as per vaccine policy; • if candidate vaccine is provided, include in national surveillance system for monitoring adverse events; and • transfer available vaccination equipment from stockpile to states and territories, if appropriate.
<p>Clinical care & public health management</p>	<ul style="list-style-type: none"> • Provide antivirals for cases; • provide antivirals as prophylaxis to agreed target groups; • monitor and support needs of at-risk groups; • encourage voluntary isolation of people with Influenza-Like-Illnesses (ILI); • manage contacts; • support outbreak investigation and management in residential care facilities, schools, prisons and other institutions; • encourage advance planning directives of nursing home residents; • prepare to surge staffing levels; • consider strategies to reduce routine hospital demand; • develop and disseminate triage algorithm; and • develop cohort strategy.
<p>Infection control</p>	<ul style="list-style-type: none"> • Confirm with responders the application of standard infection control strategies (or provide alternate advice if appropriate); • provide advice to the public on respiratory hygiene and hand-washing.

Identification

<p>Surveillance (see Surveillance Plan for more detail)</p>	<ul style="list-style-type: none"> • Identify and describe the epidemiology, clinical severity and virology of the disease in Australia through enhanced surveillance of confirmed cases (including FF100—see Surveillance Plan for description). (This will be commenced in the Preparedness or standby stages and will focus here on entry of the disease into Australia and early Australian cases); • compare any information about the overall pandemic with seasonal influenza to inform appropriate interventions; • refine case definitions as needed; • confirm identification of at-risk groups; • analyse and report Australian data; and • maintain case notification system; activate academic studies using enhanced data to test assumptions; monitor sustainability of surveillance systems.
---	--

Laboratory Capacity	<ul style="list-style-type: none"> • Isolate the virus (if not already undertaken); • undertake laboratory testing as required to monitor the pandemic and for individual patient care; • develop POC testing to enable timely diagnosis with early discharge, use of antivirals and appropriate cohorting of admitted patients; • implement testing protocols to support case management, surveillance needs and to preserve laboratory capacity; and • maintain laboratory capacity/capability to detect/test for novel virus.
---------------------	---

Communications (see Communications Chapter for more detail) Information should be provided as early as possible and acknowledge any associated uncertainty.

Sharing information between responders	<ul style="list-style-type: none"> • Provide public health management guidance; • provide clinical health management guidance (primary care and hospital based); • provide advice on antiviral use; • share information on the status of disease spread and the current response; • raise awareness of at-risk groups; • provide any information to WHO required under IHR reporting arrangements; and • liaise with other international counterparts.
Public Communications	<ul style="list-style-type: none"> • Coordinate public messaging by convening NHEMRN; • coordinate WoG messaging to provide information on the status of disease spread and the current response; • provide specific information for groups at-risk or with specific needs (e.g. CALD, aged care or Aboriginal and Torres Strait Islander peoples); • monitor feedback and refine communications to address issues and concerns identified; • provide media with access to daily updates on the status of disease spread and the current response; • provide access to background information; • make spokespeople available; • respond to media requests; • provide advice on: <ul style="list-style-type: none"> - respiratory hygiene and hand-washing; - mask wearing (if appropriate); - how to find out more information; and • hotline details (if any).

(Communication measures related directly to infection control and border are included in those sections.)

Border activities

Border measures	<ul style="list-style-type: none"> • Implement enhanced border measures, such as enhanced entry screening, non-automatic pratique, preventative biosecurity measures.
Communications	<ul style="list-style-type: none"> • Provide information to travellers through: <ul style="list-style-type: none"> - in-flight announcements; - communication materials (e.g. printed and electronic media) at the border; and - social media. • provide guidance for border workers on: <ul style="list-style-type: none"> - the disease and personal risk; - respiratory hygiene and hand-washing; - appropriate use of PPE while assessing ill travellers; and - where to find more information.
Traveller clearances	<ul style="list-style-type: none"> • Maintain requirements for customs, immigration and biosecurity clearances (including for Australian Defence Force Personnel).

Governance

AHPPC	<ul style="list-style-type: none"> • Coordinate allocation of national resources to support quality care and public health measures; • consider widening prescription rights for nurses to include antiviral drugs and other key medications; • consider changing scheduling of influenza antiviral drugs to facilitate widespread use according to national recommendations; • consider whether any social distancing measures should be implemented and advise AGCC/NCC as appropriate; • consider support for the repatriation of Australians from overseas, if required; • manage requests for exit screening; and • coordinate provision of Australian Medical Assistance Teams in response to requests for international assistance (if appropriate).
Whole of government	<ul style="list-style-type: none"> • Convene the AGCC/NCC and other relevant expert committees as required; and • Minister for Health assumes emergency powers under the <i>Biosecurity Act 2015</i>, if required to support pandemic response measures.
Legislation	<ul style="list-style-type: none"> • Declare a human biosecurity emergency under the <i>Biosecurity Act 2015</i>, if required to support pandemic response measures (Governor General); and • undertake any state based legislative processes required to support implementation of disease control measures.
International obligations	<ul style="list-style-type: none"> • Meet IHR reporting requirements.

Targeted Action stage

The Targeted Action stage will commence when there is sufficient information collected during the Initial Measures stage to inform refinement of the pandemic response measures already implemented. Measures will be regularly reviewed as more information becomes available.

Targeted measures will focus on:

- supporting and maintaining **quality care**;
- ensuring a **proportionate response**;
- communications to **engage, empower and build confidence in the community**; and
- providing a **coordinated and consistent approach**.

Identification measures will move to collecting core data from established surveillance systems in order to detect any changes in the epidemiology of those getting sick, the clinical severity of the disease or characteristics of the virus. Jurisdictions will continue to collect enhanced data on up to 10 cases per week and for outbreaks in new settings.

Communication measures will continue to be important, following the same approach as outlined in the Initial Action section above. Key messages should continue to be reviewed regularly to ensure they reflect current information about the response, the disease itself and recommended management strategies (both for responders and the public) (see Communications Chapter of AHMPPI for more detail).

In the Targeted Action stage, the following measures could be considered for implementation:

Supporting and maintaining quality care

Resources

(HR & stockpile)

- Monitor health system capacity;
- health services will implement surge staff arrangements as needed (and where possible);
- health services will prioritise services to best meet demand for acute care;
- S/T HD will undertake urgent assessment and coordination of available specialist equipment such as ECMO machines and ventilators (in collaboration with the private sector) based on pandemic predictions and geographic spread;
- retrieval services will implement pandemic and surge capacity plans;
- maintain the NIR (staff, equipment, management systems);
- provide PPE, candidate pandemic vaccines and/or antiviral PrEP as appropriate (healthcare workers/ Border workers);
- distribute stockpile items as agreed by AHPPC;
- provide additional support to health systems in remote communities as needed (and where possible).
- Tailor measures to the needs of remote communities (including remote Aboriginal and Torres Strait Islander communities)*. This may include arrangements for additional healthcare workers.

*Great distances will present difficulties for transport of resources, personnel, patients and communications. Some remote health care services will already be challenged by poor health hardware and high rates of overcrowding. The additional burden of even a mild pandemic will stress capacity. In combination with higher rates of chronic illness these factors predispose people in these areas to more severe outcomes from influenza. Cultural and environmental differences will influence the effectiveness of certain measures, such as home quarantine. This remoteness may however give greater opportunities for effectively managing transmission into the community.

Vaccination	<ul style="list-style-type: none"> • Fast-track assessment and approval of the customised pandemic vaccine; • implement pandemic specific immunisation program when customised vaccine is available; • monitor vaccine uptake; and • monitor AEFI to ensure early detection of any safety signals.
Clinical care & public health management	<ul style="list-style-type: none"> • Provide antivirals for cases; • provide antivirals as prophylaxis to agreed target groups; • encourage voluntary isolation of people with ILIs; • triage and cohort patients, as necessary; • manage contacts as agreed by AHPPC; • support outbreak investigation and management in residential care facilities, schools, prisons and other institutions; • consider using different strategies to treat mild cases where resources are overwhelmed; • new models of care may be instituted to manage influenza patients, for example: <ul style="list-style-type: none"> - innovative methods for contact tracing and supply of antivirals (call centres etc.); - home based care, which may require contingency community services support (potentially telephone support); - influenza clinics staffed predominantly by nurses via management protocols, with onsite or telephone medical support; and • adjustment of ICU staffing ratios and opening of new ICU beds.
Infection control	<ul style="list-style-type: none"> • Continue application of agreed infection control strategies appropriate to increasing knowledge of transmissibility; and • continue to provide advice to the public on respiratory hygiene and hand-washing.

Governance

AHPPC	<ul style="list-style-type: none"> • Services in each jurisdiction will provide information on their capacity to State and Territory Chief Health Officers (CHOs) to allow state level coordination. In turn, CHOs will report to AHPPC to enable national coordination and sharing/ allocation of resources where needed and where possible; • AHPPC members will work together to coordinate the availability of resources and to develop strategies for alternate sources where needed; • wherever possible, AHPPC members will work together to ensure all needs are met and a consistent approach and message is maintained; • discussion and negotiation through AHPPC will achieve coordination of measures and provide a vehicle through which jurisdictions can negotiate approaches and ensure that when different strategies are operating across jurisdictions they are still supportive of each other; • consider whether any social distancing measures should be implemented and advise AGCC/NCC as appropriate; and • consider support for the repatriation of Australians from overseas, if required.
WoG	<ul style="list-style-type: none"> • Make recommendations through WoG channels when implementation of measures outside the health sector should be considered, such as school or workplace closures.
International obligations	<ul style="list-style-type: none"> • Meet IHR reporting requirements.

Standdown stage

Individual activities will be regularly assessed and stood down when they no longer contribute to the AHMPPI's goals. The **trigger** for the AHMPPI as a whole to move into the Standdown stage will occur when advice from CDNA indicates that the pandemic has reached a level where it can be managed under seasonal influenza arrangements.

Standdown activities will focus on:

- supporting and maintaining **quality care**;
- **ceasing** activities that are no longer needed, and **transitioning** activities to seasonal or interim arrangements;
- monitoring for a **second wave** of the outbreak;
- monitoring for the development of antiviral resistance;
- communications activities to support the **return** from **pandemic to normal** business services; and
- **evaluating** systems and **revising** plans and procedures.

In the Standdown stage, the following measures could be considered for implementation:

Communications (see Communications Chapter for more detail)

Sharing information between responders	<ul style="list-style-type: none">• Advise of the commencement of transition to seasonal arrangements and how this will be managed;• thank responders for their engagement in the response;• acknowledge the Recovery efforts that will be occurring;• provide information about the review process; and• (at the end of standdown) notify stakeholders of the transition to ongoing vigilance to ensure we are well placed to respond in future.
Public Communications	<ul style="list-style-type: none">• Coordinate public messaging through NHEMRN;• notify the public that services will transition to normal arrangements and the reason for this;• provide specific information for groups at risk or with specific needs (e.g. CALD, aged care or Aboriginal and Torres Strait Islander peoples) about the transition of services;• thank the public for their engagement in the response;• provide information about the review process;• (at the end of standdown) notify of the transition to ongoing vigilance to ensure we are well placed to respond in future;• monitor feedback and refine communications to address issues and concerns identified;• provide the media with access to information regarding the change of the status of disease spread and the transition of the response;• make spokespeople available; and• respond to media requests.

Supporting and maintaining quality care

Resources (HR)	<ul style="list-style-type: none"> • Support any resources that are depleted, in order to meet remaining demand; and • implement interim arrangements if required.
Resources (stockpile)	<ul style="list-style-type: none"> • Assess the status of stockpiles and equipment (antivirals, antibiotics, PPE); • review processes; • replenish stocks as appropriate; and • update plans/protocols in line with lessons observed.
Clinical care & public health management	<ul style="list-style-type: none"> • Implement interim arrangements if required; • transition triage and cohorting systems; • resume elective procedures (hospitals); • resume non-urgent work (primary and secondary care); • review processes; and • update plans/protocols in line with lessons observed.
Vaccination	<ul style="list-style-type: none"> • Transition pandemic vaccination program (this may continue past Standdown); • terminate supply contracts; • review processes; • update plans/protocols in line with lessons observed; • replace vaccination equipment in stockpile if appropriate; and • cease active surveillance of AEFI for the pandemic influenza vaccine.
Legislation	<ul style="list-style-type: none"> • Prepare and action any legislative instruments required to return legislative powers to normal.

Identification

Surveillance (see Surveillance Plan for more detail)	<ul style="list-style-type: none"> • Monitor for a second wave or change in the virus; • continue academic studies and analysis of data from both enhanced and routine surveillance systems as necessary; • review processes; and • update Surveillance Plan in line with lessons observed.
Laboratory capacity	<ul style="list-style-type: none"> • Monitor for a second wave or change in the virus; • review processes; and • update plans/protocols in line with lessons observed.

Border activities

Border measures	<ul style="list-style-type: none"> Stand down enhanced border measures and return to business as usual arrangements.
Communications	<ul style="list-style-type: none"> Update in-flight announcements to reflect transition; implement signage (such as crawlers on customs screens or posters) explaining transition; update social media messages for travellers (if used); review any disease specific communication materials; review processes; and update plans/protocols in line with lessons observed.
Liaison	<ul style="list-style-type: none"> Advise airline/airport, seaport/shipping industries and border agencies of transition to normal business arrangements.

Governance

AHPPC	<ul style="list-style-type: none"> Services in each jurisdiction will provide information on their capacity to State and Territory Government CHOs to allow state level coordination. In turn, CHOs will report to AHPPC to enable national coordination and sharing/allocation of resources where needed and where possible; coordinate the availability of resources and to develop strategies for alternate sources where specific areas are depleted; ensure a consistent message is maintained; coordinate the transition to standdown, as this may differ among jurisdictions; and direct and participate in review processes. consider updated plans/protocols.
WoG	<ul style="list-style-type: none"> Make recommendations through WoG channels where implementation of measures outside the health sector should be stood down, such as school or workplace closures and enhanced border measures; and participate in WoG review processes.
International obligations	<ul style="list-style-type: none"> Meet IHR reporting requirements.

PART 3

Support Documents

Attachment A. Glossary

AAHL	Australian Animal Health Laboratory
Access Block	Refers to the percentage of patients who were admitted or planned for admission but discharged from the ED without reaching an inpatient bed, transferred to another hospital for admission, or died in the ED whose total ED time exceeded 8 hours, as per the ACEM P02 Policy on Standard Terminology.
ACCHS	Aboriginal Community Controlled Health Services. ACCHSs operate in the metropolitan, regional, rural and remote areas of all states and territories in Australia. ACCHSs are controlled by, and accountable to, Aboriginal people in those areas in which they operate. ACCHSs aim to deliver holistic, comprehensive and culturally appropriate health care to the community that controls it.
ACEM	Australasian College for Emergency Medicine
ACIPC	Australasian College for Infection Prevention and Control
ACSQHC	Australian Commission on Safety and Quality in Healthcare
Acute Care	Health services (usually hospitals) that provide care or treatment of people with short-term serious injury or illness. Medical conditions requiring acute care are typically periodic or temporary in nature, rather than long term.
AGCC	Australian Government Crisis Committee
AGCMF	Australian Government Crisis Management Framework
Aged Care Peak Bodies	Associations of groups or industries that advocate for and provide quality support, services, representation and policy development in the aged care sector.
AGD	Attorney General's Department
AHMPPI	Australian Health Management Plan for Pandemic Influenza
AHPPC	Australian Health Protection Principal Committee
AHMAC	Australian Health Ministers Advisory Council
ALGA	Australian Local Government Association
AMA	Australian Medical Association

Animal Health Australia (AHA)	AHA is a not-for profit public company established by the Australian Government, state and territory governments and major national livestock industry organisations. AHA manages national programs on behalf of members: the Australian Government, state and territory governments, peak national councils of Australia's livestock industries and service providers. These programs improve animal and human health, biosecurity, market access, livestock welfare, productivity, and food safety and quality.
ANZICS	Australian and New Zealand Intensive Care Society
APSU	Australian Paediatric Surveillance Unit
ARDS	Acute respiratory distress syndrome
ASPREN	Australian Sentinel Practices Research Network. The ASPREN currently has sentinel GPs who report ILI presentation rates in NSW, NT, SA, ACT, VIC, QLD, TAS and WA.
At-Risk groups	Groups at increased risk of experiencing complications from influenza infection.
ATAGI	Australian Technical Advisory Group on Immunisation
AUSMAT	Australian Medical Assistance Teams
Australian Government	The Federal Government of Australia
AV	Antiviral
BDMs	Births, Deaths and Marriages
CALD	Culturally and linguistically diverse communities
Candidate vaccine	A vaccine based on a strain of influenza virus considered to have pandemic potential. This vaccine may provide partial protection if it develops into a pandemic strain that is easily transmissible between humans.
CAR	Clinical Case Attack Rate
Case definition	A set of uniform criteria used to define a disease for public health surveillance (US CDC).
CDNA	Communicable Diseases Network Australia
CDPLAN	Emergency Response Plan for Communicable Disease Incidents of National Significance
CHBO	Chief Human Biosecurity Officer
CHC	COAG Health Council
CHO	Chief Health Officer
CMO	Chief Medical Officer of Australia
COAG	Council of Australian Governments

COMDISPLAN	Commonwealth Government Disaster Response Plan
Commonwealth	The governments of Australia—Australian Government and state and territory governments collectively
Comms	communications
Community transmission	Community transmission is the passing of a disease from an infected individual to another individual outside of a known group of contacts, and outside health care settings.
Contact tracing	The process of identifying and managing people who have been ‘in contact’ with someone who has an infectious illness.
Cough and sneeze etiquette	Measures individuals can take when we cough, sneeze or blow our nose, to reduce the change of spreading the virus. This is sometimes referred to as respiratory hygiene.
CPD	Continuing Professional Development
CS	clinical severity
CSF	Clinical Stakeholders Forum
Customised pandemic vaccine	A vaccine based on the actual pandemic virus, which cannot be developed until the next pandemic virus emerges.
Department of Health / Dept. Health	Australian Government Department of Health
Depts. Primary Industry	State and territory departments of primary industry
DFAT	Department of Foreign Affairs and Trade
DHB	Director of Human Biosecurity (Australia’s Chief Medical Officer)
DSM	Decision Support Map
ECDC	European Centre for Disease Prevention and Control
ECMO	Extracorporeal membrane oxygenation
ED	Emergency department
Epidemic	An outbreak or unusually high occurrence of a disease or illness in a population or area
EpiLOG	Data matching software used by Queensland to match hospitalisations and notifications.
FF100	Data matching software used by Queensland to match hospitalisations and notifications.

First Ministers	The Prime Minister of Australia, premiers of the states and Chief Ministers of the territories
Flu clinic	Flu clinics are specially planned facilities that will be set up during a pandemic for safe medical assessment and management of people with suspected pandemic influenza.
FluCAN	<p>The Influenza Complications Alert Network (FluCAN) sentinel hospital system monitors influenza hospitalisations. There is at least one hospital in each jurisdiction that participates in this network.</p> <p>Influenza counts are based on active surveillance at each site for admissions with PCR-confirmed influenza in adults. Some adjustments may be made in previous periods as test results become available. ICU status is as determined at the time of admission and does not include patients subsequently transferred to ICU.</p>
FluTracking	<p>FluTracking is a project of the University of Newcastle, the Hunter New England Area Health Service and the Hunter Medical Research Institute. FluTracking is an online health surveillance system to detect epidemics of influenza. It involves participants from around Australia completing a simple online weekly survey, which collects data on the rate of ILI symptoms in communities.</p> <p>Further information on FluTracking is available at www.flutracking.net/index.html.</p>
GISRS	Global Influenza Surveillance and Response System
GP	General Practitioners
GPRT	General Practice Roundtable
HCAI	Health care associated infection
HCP	Health Care Professional
HCW	Health Care Worker (Defined as doctors, nurses, paramedics and other front line medical personnel)
HDC	Health declaration cards
Health sector	The health sector is government departments responsible for health, the public and private health system, in addition to the private and public health system, and health professionals.
High Risk groups	Groups at increased risk of experiencing complications from influenza.
hosp	Private and public hospitals
HR	Human resources
IAR	Infection attack rate
ICAO	International Civil Aviation Organization
ICU	Intensive Care Unit
IHR	International Health Regulations 2005
ILI	Influenza Like Illness

Infectious	Capable of spreading disease or a disease that is capable of spreading (also known as communicable).
lab	Laboratories
LCD	Laboratory case definition
LHD	Listed human disease. A disease which the DHB considers may be communicable and cause significant harm to health. LHDs are determined in the <i>Biosecurity (Listed Human Diseases) Determination 2016</i> , enabling a range of powers and measures to become available to manage the risk under the <i>Biosecurity Act 2015</i> .
Meas.	Measures
MO	Minister's Office
Morbidity	State of disease. The term morbidity rate refers to the numbers of cases of illness in a population divided by the total population considered at risk of that illness.
Mortality	Death—mortality rate is the measure of the number of dead (in general, or due to a specific cause) in a population scaled to the size of that population, per unit time.
MTAA	Medical Technology Association of Australia
NA	Neuraminidase
NACCHO	National Aboriginal Community Controlled Health Organisations
NAI	Neuraminidase inhibitors (antivirals such as oseltamivir and zanamivir)
National	The Australian Government, and State and Territory governments
National CD Plan	Emergency Response Plan for Communicable Disease Incidents of National Significance: National Arrangements
NCC	National Crisis Committee
Negative pratique	Aircraft commanders must report the health status of passengers on board before landing, rather than the normal reporting by exception
NetEpi	Open source software designed to assist with epidemiological investigations, analyses, and other aspects of public health practice.
NFP	The area or areas within the Department of Health, designated under the Act, as the IHR National Focal Point to liaise with and facilitate actions by national and international bodies to prevent, protect against, control and respond to a Public Health Event of National Significance or a Public Health Emergency of International Concern.
NHCCN	National Health Call Centre Network
NHEMRN	National Health Emergency Response Network
NHEMS	National Health Emergency Management Standing Committee

NHMRC	National Health and Medical Research Council
NHS Act	<i>National Health Security Act 2007</i>
NIC	National Immunisation Committee
NICs	National Influenza Centres
NIP	National Immunisation Program
NIR	Department of Health National Incident Room
NISC	National Influenza Surveillance Committee
NMS	Australia's National Medical Stockpile
NNDSS	National Notifiable Diseases Surveillance System
NSC	National Security Committee of Cabinet
NZ	New Zealand
Other A. Gov	Other Australian Government departments
P2 Mask	A P2 mask (P2 respirator) is a device specifically designed to provide protection to the wearer's respiratory tract from small infectious particles. A P2 mask is a particulate filter, personal respiratory protection device which, when tested against AS/NZS 1716:2003, does not show penetration of particles with a mass median diameter of 0.3 micro meters, of more than 6%.
PAEDS	Paediatric Active Enhanced Disease Surveillance
Pandemic	An epidemic on a global scale. Only Type A influenza viruses have been known to cause influenza pandemics.
PCR	Polymerase Chain Reaction
PEP	Post Exposure Prophylaxis
PHIL	Public Health Information Line
PHLN	Public Health Laboratory Network
PHN	Primary Health Networks
PHU	Public Health Unit
PLC	Passenger locator cards
PLFs	Passenger locator forms
POC testing	Point of Care testing
Point of care	The place where three elements come together: the patient, the HCW, and care or treatment involving contact with the patient or his/her surroundings (WHO Guidelines on hygiene in healthcare)

Post-exposure prophylaxis	A dose or doses of a drug (usually antibiotic or antiviral) given immediately after exposure to a disease (such as influenza), but before onset of illness.
PPE	Personal Protective Equipment (gowns, gloves, masks)
Pre-exposure prophylaxis (PrEP)	A dose or doses of a drug (usually antibiotic or antiviral) given before exposure to a disease, to protect the person from being infected.
Primary care	Health services providing initial care of a patient before they are referred to transferred elsewhere. General practice surgeries and emergency departments are common sites for primary care.
ProMED	Program for Monitoring Emerging Diseases
Prophylaxis	Medical or public health procedure designed to prevent infection, rather than treat or cure existing disease.
Public Health Medical Officers Network	The collective term for all Public Health Medical Officers. Public Health Medical Officers are based in the State/Territory based affiliates of NACCHO. Their role is to support, strengthen and assist the work of NACCHO State and Territory affiliates to expand and implement the growing number of public health activities. A Senior Aboriginal Public Health Medical Officer (SAPHMO) provides leadership and coordination of the National Public Health Medical Officer group.
Quarantine	The limitation of freedom of movement for a period of time of well persons who are likely to have been exposed to the virus (contact) to prevent their contact with people who have not been exposed.
RACF	Residential Aged Care Facilities
RACGP	Royal Australian College of General Practitioners
RACP	Royal Australian College of Physicians
RANZCOG	Royal Australian and New Zealand College of Obstetricians and Gynaecologists
Resilience	The capacity to cope with stress or change, and capacity to adapt.
S/T	States and territories
S/T HD	State and territory health departments
SARS	Severe Acute Respiratory Syndrome
SCAHLs	Sub-Committee on Animal Health Laboratory Standards
Serial interval	Average length of time between an initial primary case developing symptoms and subsequent secondary cases developing systems.
SoNGs	Series of National Guidelines. CDNA National Guidelines for Public Health Units on the control of communicable diseases.
TG	Therapeutic Goods
TGA	Therapeutic Goods Administration

WHO	World Health Organization
WHO NIC	WHO National Influenza Centres
WHOCC	WHO Collaborating Centre for Reference and Research on Influenza
WoG	Whole of Government

Attachment B. Decision Making Committees

(as per diagram in Governance Chapter)

Table 2: List of Decision Making Committees

Committee	Reports to	Function
WHOLE OF GOVERNMENT DECISION MAKING		
National Security Committee of Cabinet (NSC)	n/a	NSC is the Government's highest decision-making body on Australia's national security. NSC focuses on major international security issues of strategic importance to Australia, border protection policy and national responses to developing situations (either domestic or international). NSC is convened to ensure coordinated, timely government action and to set priorities for response, recovery and communication strategies. NSC is chaired by the Prime Minister. The current membership consists of the Deputy Prime Minister, the Treasurer, the Defence Minister, the Foreign Minister and the Attorney-General.
Council of Australian Governments (COAG)	n/a	COAG is the peak intergovernmental forum in Australia. The role of COAG is to promote policy reforms that are of national significance, or which need coordinated action by all Australian governments. The members of COAG are the Prime Minister, State and Territory Premiers and Chief Ministers and the President of the Australian Local Government Association.
National Crisis Committee (NCC)	NSC	NCC is the primary forum for coordinating whole-of-government response to an incident of national significance including consolidation of information and coordination of information exchange, advice to ministers and coordination of ministerial decisions across the Federal, State and Territory governments. Membership of the NCC includes the Australian Government Crisis Committee members plus senior representation from the First Ministers' departments and the relevant police and emergency services agencies in each jurisdiction.
Australian Government Crisis Committee (AGCC)	NSC	AGCC is a coordination body comprised of senior officials from Australian Government agencies and chaired by the Department of Prime Minister and Cabinet Associate Secretary for National Security. The AGCC may convene in response to any crisis, including a terrorist act, where the scope and resourcing of Australian Government support to states and territories requires senior officials' level coordination.

Committee	Reports to	Function
HEALTH SECTOR DECISION MAKING		
COAG Health Council (CHC)	Council of Australian Governments	<p>CHC's responsibilities include health related elements of emergency management and national security.</p> <ul style="list-style-type: none"> Membership: Australian Government, state, territory and New Zealand Ministers with responsibility for health matters, and the Australian Government Minister for Veterans' Affairs.
Australian Health Ministers Advisory Council (AHMAC)	CHC	<p>AHMAC supports CHC by providing strategic advice on health issues and by acting as a forum for planning, information sharing and innovation</p> <ul style="list-style-type: none"> Membership: chief executive officers of Australian Government, state and territory, and New Zealand departments that have responsibility for health.
Australian Health Protection Principal Committee (AHPPC)	AHMAC	<p>AHPPC is the key advisory body to health ministers and is the peak strategic decision making committee for planning for and response to health emergencies. It facilitates the development of national health emergency policies, guidelines and standards, and coordinates a cross-jurisdictional health response to health emergencies.</p> <ul style="list-style-type: none"> Core membership: Chief Medical Officer; Chief Health Officer of each State and Territory; chairs of each of the three sub-committees (CDNA, PHLN, EnHealth); Emergency Management Australia; Defence health services; NZ Health; National Mental Health Disaster Response Committee.
Therapeutic Goods Administration (TGA)	Australian Government Assistant Minister for Health	<p>TGA is part of the Australian Government Department of Health (Department of Health). The TGA's overall purpose is to protect public health and safety by regulating therapeutic goods that are supplied either imported or manufactured, or exported from Australia. Therapeutic goods include medicines, medical devices and human blood, blood products, tissues and vaccines.</p> <p>As part of this function, the TGA registers new pharmaceuticals and vaccines as approved for use in Australia, following assessment of quality, safety and efficacy. The TGA also monitors and reports adverse events from antiviral drugs and pandemic vaccines and provides advice on safety.</p>

Committee	Reports to	Function
HEALTH ADVISORY GROUPS		
National Health Emergency Management Standing Committee (NHEMS)	AHPPC	<p>NHEMS addresses the operational aspects of disaster medicine and health emergency management in an all hazards context, with a focus on Preparedness and Response. NHEMS advises the Australian Health Protection Principal Committee on activities to strengthen disaster health infrastructure and capacity nationally, and on national coordination of the health sector in response to disasters.</p> <ul style="list-style-type: none"> • Membership: Australian, state and territory governments and national organisations, a New Zealand health representative and subject matter experts dependent on the issue being considered.
Public Health Laboratory Network (PHLN)	AHPPC	<p>It provides leadership and consultation in all aspects of public health microbiology and communicable disease control; and strategic advice to the AHPPC to identify gaps and needs.</p> <p>It also ensures optimal use of existing pathology laboratory resources for communicable disease surveillance and for response to outbreaks of national importance, and develops laboratory case definitions to be used for diagnosis of certain communicable diseases.</p> <ul style="list-style-type: none"> • Membership: State and Territory public laboratory representatives, expert (WHOCC), national (AAHL, CDNA) and observer members (private pathology, Technical and Forensic Intelligence, AFP, and New Zealand).
Communicable Diseases Network Australia (CDNA)	AHPPC	<p>CDNA is a sub-committee of AHPPC. It provides national public health coordination on communicable disease surveillance, prevention and control, develops case definitions and guidelines, and offers strategic advice to governments and other key bodies on public health actions to minimise the impact of communicable diseases in Australia and the region.</p> <p>CDNA is the central coordinating body for public health response advice in a pandemic.</p> <p>Membership: State and Territory communicable diseases managers; chair of the NIC; experts representing a range of organisations.</p>

National Influenza Surveillance Committee (NISC)	CDNA	<p>NISC's role is to maintain national and regional influenza surveillance systems in order to provide high-quality and timely information on influenza activity and better prepare and support Australian health systems for influenza epidemics and pandemics.</p> <ul style="list-style-type: none"> Membership: CDNA representative (chair); Department of Health; New Zealand and State and Territory representatives; representatives from PHLN, Paediatric Active Enhanced Disease Surveillance (PAEDS), WHO CC and NICs; and influenza surveillance systems managers.
National Immunisation Committee (NIC)	CDNA	<p>NIC is the peak group responsible for overseeing the development, implementation and delivery of the National Immunisation Program. This includes leading policy development and evaluation, providing advice on strategic direction and on communication strategies, consulting with stakeholders and other immunisation committees (including ATAGI) on development of national priorities, strategies and service delivery.</p> <ul style="list-style-type: none"> Membership: Department of Health (chair); State and Territory nominees; peak bodies (nursing, general practice, Aboriginal and Torres Strait Islander health); CDNA representative; a consumer representative.
Australian Technical Advisory Group on Immunisation (ATAGI)	Chief Medical Officer	<p>ATAGI provides technical advice to the Minister for Health on the National Immunisation Program and other related issues including matters relating to vaccine efficacy and safety, and the implementation of immunisation policies and procedures. ATAGI reviews novel vaccine formulations and reviews pandemic response recommendations relevant to the use of vaccines. ATAGI currently has an Influenza Working Party, which assists in the provision of advice. ATAGI also produces the Australian Immunisation Handbook.</p> <ul style="list-style-type: none"> Membership: technical expertise including paediatric medicine, public health, infectious diseases and immunology, general practitioners, Department of Health, TGA, NCIRS, CDNA, NIC and a consumer forum representative.
National Health Emergency Media Response Network (NHEMRN)	Chief Medical Officer	<p>NHEMRN's role is to keep the public and the media informed during national health emergencies by providing consistent and coordinated media and public responses. It is managed by the Department of Health.</p> <ul style="list-style-type: none"> Membership: all health departments media units representatives; relevant Australian Government agencies, national medical colleges and associations, and select parts of the private sector directly involved in emergency health management.

Chief Human Biosecurity Officers (CHBOs)	Chief Medical Officer	<p>The CHBOs collectively provide advice to the CMO (as the DHB) and to the Department of Health on human biosecurity matters. Meetings, consultation and CHBO appointments are coordinated by the Department of Health. CHBO appointments are nominated by state and territory health departments.</p> <ul style="list-style-type: none"> Membership: State and territory communicable disease managers appointed as CHBOs by the Department of Health under the <i>Biosecurity Act 2015</i>. CHBOs are often also members of CDNA.
---	-----------------------	---

HEALTH CONSULTATIVE FORA		
GP Roundtable (GPRT)	n/a	<p>GPRT is an informal discussion group led by the Department of Health.</p> <ul style="list-style-type: none"> Membership: CMO, Department of Health representatives, Australian Medical Association, Australian Practice Nurses Association, Australian Medicare Local Alliance, Rural Doctors Association of Australia, Australian College of Rural and Remote Medicine, Royal Australian College of General Practitioners, Australian College of Nurse Practitioners, Australian Indigenous Doctors' Association, National After Hours Medical Deputising Service.
Clinical Stakeholders Forum (CSF)	n/a	<p>CSF is a group convened by the CMO to provide specialist clinicians with access to the AHPPC to build and maintain information links between policy and clinical management.</p> <ul style="list-style-type: none"> Membership: by invitation.
National Aboriginal Controlled Community Health Organisations (NACCHO)	n/a	<p>NACCHO is the national peak body representing over 150 Aboriginal Community Controlled Health Services across the country on Aboriginal health and wellbeing issues.</p>
Aged Care Peak Bodies	n/a	<p>Associations of groups or industries that advocate for and provide quality support, services, representation and policy development in the aged care sector.</p>

Attachment C. Communication materials

Key Communication Messages Template

Communications will be central to many aspects of the response. The Australian Health Protection Principal Committee (AHPPC) will play a key role in ensuring communications are consistent by determining what the key messages are in different stages. These can then be adapted by stakeholders to meet the needs of their target audience and the purpose of communications, and distributed. The National Health Emergency Media Response Network (NHEMRN) will coordinate the distribution of messages to the public.

The information below is designed to support AHPPC in the development of consistent, comprehensive messages. It is based on the World Health Organization (WHO) description of best practice for communicating with the public during an outbreak.

This is what we know.	Provide information on the current status of the pandemic, overseas and in Australia.
	Provide information about the disease itself that is relevant to the audience.
	Characterise the pandemic impact level anticipated, based on current evidence. (This should be considered in terms of managing expectations.)
This is what we don't know.	Acknowledge the level of uncertainty at the current time.
This is what we are doing.	Provide information about P reparedness or R esponse activities. Note continuing collection of surveillance data and monitoring.
This is what you can do.	Provide information on how the audience can contribute to the AHMPPI's strategic objectives of <ol style="list-style-type: none"> 1. Minimising morbidity and mortality; 2. Minimising the burden on/ support health systems; and 3. Informing and empowering the public.
	Advise the audience where further information can be obtained.

An example of the key messages suitable for communications being distributed to the general public during the Initial Action stage has been provided below as an illustration of the use of the template.

<p>This is what we know.</p>	<p>Key messages:</p> <ul style="list-style-type: none"> • (The disease) is now widespread across Asia, particularly in x, y and z countries. The number of people with the disease is still increasing. • The governments of these countries are working together with the WHO to slow the transmission of the disease and to provide treatment and care for those who are infected. • It is recommended that non-essential travel to x country should be postponed if possible. • There are now a small number of people in Australia who are believed to have x (the disease). They are receiving treatment and support. • The information we have so far suggests that this disease is very easily passed from one person to another and that in most people it will cause a moderate illness, though men between 40 and 55 years of age and people from Aboriginal and Torres Strait Islander backgrounds are more likely to experience a more serious illness.
<p>This is what we don't know.</p>	<ul style="list-style-type: none"> • This is a new type of influenza virus so our understanding of how it will affect people and how easily it will move through our community is imperfect.
<p>This is what we are doing.</p>	<ul style="list-style-type: none"> • We are working hard to obtain as much information as possible about how the disease has behaved overseas to help us manage its impact on the Australian community as effectively as possible and we will continue to refine our arrangements as more information becomes available. • We are also collecting information about cases in Australia as they appear so that we can fully understand how the disease behaves in the Australian context. • As the most effective way of preventing infection with x disease is vaccination, we have contracted x company to develop a vaccine for this disease. It is expected that this will be available in x months. • Health systems are preparing to manage people with this disease and to meet any increased demand on their services. • Based on our current knowledge of the disease, we have developed expert guidance to support people in our health system to <ul style="list-style-type: none"> - Identify someone likely to have this disease; - Undertake testing to confirm this; and - Provide effective treatment. • People identified as having this disease are receiving treatment and support.
<p>This is what you can do.</p>	<ul style="list-style-type: none"> • Normal hand hygiene, cough and sneeze etiquette should be recommended. • The main symptoms of this disease are <ul style="list-style-type: none"> - A high fever - A cough - Fatigue • Those who believe they are experiencing these symptoms should contact their GP by telephone, or contact the Public Health Information Line.

Information sharing

The following table explores potential methods of sharing information in each of the AHMPPI stages. It is colour coded to highlight separately the methods for communicating with people in the health sector responding to the pandemic, with the media or the general public, or with both, as follows:

Materials designed for



= responders



= primarily public or media



= responders and the public

Specific methods may vary at the time of the pandemic, however information will be shared on all the topics below.

Preparedness

Table 3: Methods of sharing information during the preparedness stage.

Information about	Method	Responsible agency
the international situation	Information from WHO Event Information Site (forwarded to contacts in S/T)	Department of Health
	Presentation and discussion at AHPPC	AHPPC members
	Australian Influenza Surveillance Report	Department of Health
the epidemiology, severity and virology of seasonal influenza	Australian Influenza Surveillance Report (Department of Health, Australian Influenza Surveillance Report and Activity Updates, http://www.health.gov.au/internet/main/publishing.nsf/content/cda-surveil-ozflu-flucurr.htm) analyses national influenza activity, including descriptive epidemiology and virology as well as indicators of disease severity. Data are collected through a suite of national and sentinel influenza surveillance systems. Systems monitor across the spectrum of severity including community influenza-like illness (Flutracking), GP influenza-like illness presentations (Australian Sentinel Practice Research Network—ASPREN) and hospitalisations and ICU admissions (Influenza Complications Alert Network—FluCAN)	Department of Health
	Virological characterisation and drug sensitivity of influenza isolates from around Australia. (Also contained in Australian Influenza Surveillance Report)	WHOCC
	Pandemic Flu Kit	RACGP
management of seasonal influenza	Influenza Infection: CDNA National Guidelines for Public Health Units (Series of National Guidelines (SoNGs))	CDNA
	Guidelines for the Prevention, Control and Public Health Management of Influenza Outbreaks in Residential Care Facilities in Australia	CDNA
	Influ-Info Influenza Kit for Community Aged Care (for community care providers)	Department of Health

good hygiene behaviours for influenza	Paid advertising/ printed materials/electronic displays/ social media	Hand Hygiene Australia
	Hand Hygiene Australia website (www.hha.org.au/home.aspx)	WHO
	WHO Guidelines on Hand Hygiene in Health Care (whqlibdoc.who.int/publications/2009/9789241597906_eng.pdf)	WHO
	WHO Guidelines in Outpatient and Home-based Care and Long-term Care Facilities (www.who.int/gpsc/5may/hh_guide.pdf)	WHO
vulnerable groups	Influenza Infection: CDNA National Guidelines for Public Health Units (SoNGs)	CDNA
infection control	Infection control guidelines	National Health and Medical Research Council
	Pandemic Flu Kit	RACGP
	Infection Control Standards for Office Based Practices	RACGP
roles and responsibilities during a pandemic, in relation to GPs	Managing Emergencies and Pandemics in General Practice: A Guide for Preparation, Response and Recovery Pandemic Flu Kit	RACGP
disaster and pandemic practice planning	For e.g. Continuing Professional Development (CPD) modules as part of RACGP Quality Improvement (QI) & CPD Program or online disaster and pandemic training	RACGP
	Emergency plans	Primary Health Networks NACCHO Airports/airlines Seaports/shipping and cruise lines
	Pandemic Flu Kit	RACGP
	Managing Emergencies and Pandemics in General Practice: A Guide for Preparation, Response and Recovery Pandemic Flu Kit	RACGP

Standby

Table 4: Methods of sharing information during the Standby stage

the international situation	Information from WHO Event Information Site (forwarded to contacts in S/T)	Department of Health
	International data showing emerging trends shared through existing surveillance systems	Department of Health
	Advice on border related disease management strategies such as allowing on-travel of identified ill-travellers	CDNA
	Spokespeople will be available for talk back radio interviews	Department of Health
	Information for travellers on the smartraveller.gov.au website	Department of Health
	Information posted on the Australian Government Department of Health website (www.health.gov.au) and social media accounts	Department of Health
	Transcripts of media interviews	Department of Health
	Streaming of press conferences and interviews	Department of Health
status of the pandemic in Australia	Telephone advice from the Department of Health freecall Public Health Information Line 1800 004 599.	Department of Health
	Regular media conferences	Department of Health
	Spokespeople will be available for talk back radio interviews	Department of Health
	Information posted on S/T HD websites	S/T HD
	Information posted on the Australian Government Department of Health website (www.health.gov.au) and social media accounts	Department of Health
	Streaming of press conferences and interviews	Department of Health
	List of links to S/T HD and other key website on Australian Government Department of Health website (www.health.gov.au)	Department of Health
the disease and its severity	Sharing of surveillance information as described in the Surveillance Plan	Australian Government/ state and territory govt. surveillance systems, CDNA, PHLN, NICs, NISC, WHOCC
	Direction for GPs/Hospitals about the correct sites for information regarding the pandemic including relevant clinical advice and guidance on the Royal Australian College of General Practitioners (RACGP) website (www.racgp.org.au)	RACGP, ACEM, Dept. Health, CDNA, websites of peak bodies

the disease and its severity (cont.)	Information posted on the Australian Government Department of Health website (www.health.gov.au) and social media accounts	Department of Health
	Information posted on S/T HD websites	S/T HD
	Information for GP and ED waiting rooms-paper and TV screen savers	Hospitals, GPs
	Access to information and advice from healthcare professionals through a national call centre	National Health Call Centre Network
implementation of measures	Discussion at AHPPC meetings	AHPPC
	Key messages communicated to government health departments, border agencies and airports/airlines/seaports/shipping and cruise lines.	Department of Health
	Key messages communicated to Local Government, NACCHO affiliates and jurisdictional industry peak bodies through identified email contacts for pandemic	S/T HD NACCHO
	Paid television, radio or print advertisements concerning behaviours to be promoted, such as hygiene practices	S/T HD & Department of Health
emergency contact numbers	Department of Health contact numbers on the Australian Government Department of Health website (www.health.gov.au)	Department of Health
	State and Territory Health Department (S/T HD) contact numbers on relevant health department websites	S/T HD
	The National Health Services Directory provides information on locating health services	Department of Health, S/T HD, GPs, Pharmacies, Hospitals, Primary Health Networks, Local Area Networks

Initial and Targeted Action

Table 5: Methods of sharing information during the initial and targeted stage

Information about	Method	Responsible agency
the international situation	Presentation and discussion at AHPPC	AHPPC members
	International data showing emerging trends shared through existing surveillance systems	Department of Health
	Situation Reports	Department of Health NIR
	Information for travellers on the smartraveller.gov.au website	Department of Health
	Information posted on the Australian Government Department of Health website (www.health.gov.au) and social media accounts	Department of Health

status of the pandemic in Australia	Key messages communicated to Local Government, NACCHO affiliates and jurisdictional industry peak bodies through identified email contacts for pandemic.	S/T HD NACCHO
	Direction for GPs about the correct sites for information regarding the pandemic including relevant clinical advice and guidance on the RACGP website (www.racgp.org.au)	RACGP, ACEM, Dept. Health, CDNA, websites of peak bodies
	Regular media conferences	Department of Health/ S/T HD
	Spokespeople will be available for talk back radio interviews	Department of Health/ S/T HD
	Telephone advice from the Department of Health freecall Public Health Information Line 1800 004 599.	Department of Health
	Local arrangements such as the location of influenza clinics or vaccination services	S/T HD
	Regular updates on progress of pandemic posted on the Australian Government Department of Health website (www.health.gov.au)	Department of Health
	Links to S/T HD and other key websites on the Australian Government Department of Health website (www.health.gov.au)	Department of Health
	Information posted on S/T HD websites	S/T HD
	List of links to S/T HD websites and other key websites on the Australian Government Department of Health website (www.health.gov.au)	Department of Health
	Streaming of press conferences and interviews.	Department of Health
	Sharing of media announcements, media releases and status of the pandemic through the National Health Emergency Media Response Network (NHEMRN)	NHEMRN: Department of Health, State and Territory Health Departments, Australian Government agencies, national medical colleges and associations, and parts of the private sector directly involved in emergency health management NACCHO

the disease and its severity	Surveillance case definitions, as described in Surveillance Plan	CDNA
	Information outlining <ul style="list-style-type: none"> incubation and infectious period; case and contact management; chemoprophylaxis and education; vaccination; quarantine/isolation; risk assessment; infection control and use of antivirals 	CDNA
	Confirmation/identification of at-risk groups	CDNA
	Definition of minimum data set, as outlined in Surveillance Plan	CDNA
	Clinical management guidelines	CDNA
	Laboratory Case Definition	PHLN
	Guidance on <ul style="list-style-type: none"> The type of clinical specimen required Sample collection guidance Detection methodologies, such as culture, molecular methods such as Polymerase Chain Reaction, molecular characterisation (typing and sub-typing methods and serology Quality assurance considerations 	PHLN
	Laboratory Testing Protocols	PHLN
	Information regarding relevant isolates and sequencing data for test development	PHLN
	Point of care testing advice	CDNA/PHLN
	Advice that it is no longer necessary to test all cases	PHLN/CDNA
	Collation and analysis of jurisdictional data to show emerging trends, as outlined in Surveillance Plan	Department of Health
	Jurisdictional surveillance data, as outlined in Surveillance Plan	S/T HD

the disease and its severity (cont.)	Key messages communicated to Local Government, NACCHO affiliates and jurisdictional industry peak bodies through identified email contacts for pandemic.	S/T HD NACCHO
	Tailoring Infection Control Guidelines to pandemic virus	CDNA + additional expertise
	Advice regarding the need for additional action specific to institutional settings	AHPPC on advice from CDNA, jurisdictions and GP Roundtable, Clinical Stakeholders Forum
	Protocol outlining how people identified under exit screening should be managed.	AHPPC on advice from CDNA
	Telephone advice from the Department of Health freecall Public Health Information Line 1800 004 599.	Department of Health
	Health Alert Information lines with capacity to manage inbound and outbound calls. (These can be set up within 2hours)	Department of Health
	Access to information and advice from healthcare professionals through a national call centre.	National Health Call Centre Network
	Regular media conferences	Department of Health
	Spokespeople will be available for talk back radio interviews	Department of Health
	Question and Answer sheets on the Australian Government Department of Health website (www.health.gov.au)	Department of Health
	Scenario based advice (e.g. I think I might have been exposed as someone at work might have influenza, or, a child at my child's school has influenza) on the Australian Government Department of Health website (www.health.gov.au)	Department of Health
	Question and answer facility on website where queries are answered online at the Australian Government Department of Health website (www.health.gov.au)	Department of Health
	YouTube will be used to provide press conference materials (Australian Government and State and Territory Government), health information and pandemic updates	Department of Health
	Health emergency Facebook and other social media accounts will provide basic information and referrals to the health emergency website and other resources. They will be interactive—providing the public an opportunity to express their views and needs	
Fact sheets which can be adapted as required by state and territory health departments and other agencies	CDNA	

the disease and its severity (cont.)	Information for GP and ED waiting rooms-paper and TV screen savers	Hospitals, GPs
	Electronic and/or printed media at the border to raise disease awareness and behaviours to be promoted	Department of Health
	Direction for GPs/Hospitals about the correct sites for information regarding the pandemic including relevant clinical advice and guidance on the RACGP website (www.racgp.org.au)	RACGP, ACEM, Dept. Health, CDNA
	Streaming of press conferences and interviews	Department of Health
	Data, if available, on at-risk groups	Department of Health / S/T HD
	Sharing of information resources through NHEMRN (as above)	NHEMRN members
implementation of measures	Discussion at AHPPC meetings	AHPPC
	Guidance for healthcare workers on use of PPE and antivirals	CDNA
	Guidance for border workers on use of PPE	Department of Health
	Information on vaccine efficacy	ATAGI
	Information on vaccine safety	TGA
	Guidance for pathology and research staff regarding antiviral prophylaxis	PHLN
	Guidelines concerning management of influenza outbreaks in Residential Aged Care Facilities	CDNA + senior clinical advisor + Department of Health
	Key messages communicated to government health departments, border agencies and airports/airlines/seaports/shipping and cruise lines.	Department of Health
	Key messages communicated to Local Government, NACCHO affiliates and jurisdictional industry peak bodies through identified email contacts for pandemic.	S/T HD NACCHO
	Paid television, radio or print advertisements concerning behaviours to be promoted, such as hygiene practices	S/T HD Department of Health
	Electronic and/or printed media at the border to raise disease awareness and behaviours to be promoted	Department of Health
	Fact Sheets tailored to the needs of Residential Aged Care Facilities	Department of Health

implementation of measures (cont.)	Consumer information on PPE, antivirals and vaccination together with a 'frequently asked questions' section and how to contact a health professional for further advice will be available on the Australian Government Department of Health website (www.health.gov.au)	Department of Health
	Information on the vaccine delivery program.	S/T HD Department of Health GPs, nurses, ACCHSs, hospitals, RACF

Standdown

Table 6: Methods of sharing information during the standdown stage

Information about	Method	Responsible agency
the international situation	Information for travellers on the smartraveller.gov.au website	Department of Health
	Information will be posted on the Australian Government Department of Health website (www.health.gov.au) and social media accounts	Department of Health
status of the pandemic in Australia	Direction for GPs about the correct sites for information regarding the pandemic including relevant clinical advice and guidance on the RACGP website (www.racgp.org.au)	RACGP, ACEM, Dept. Health, CDNA, websites of peak bodies
	Transcripts of media interviews	Department of Health
	Streaming of press conferences and interviews	Department of Health
	Question and Answer sheets on www.health.gov.au	Department of Health
	List of links to S/T HD and other key websites on the Australian Government Department of Health website (www.health.gov.au) and social media accounts	Department of Health
	Information for GP and ED waiting rooms-paper and TV screen savers	Hospitals, GPs
	Information will be posted on the Australian Government Department of Health website (www.health.gov.au) and social media accounts	Department of Health
	Information posted on S/T HD websites	S/T HD

the disease and its severity	Direction for GPs about the correct sites for information regarding the pandemic including relevant clinical advice and guidance on the RACGP website (www.racgp.org.au)	RACGP
	Telephone advice from the Department of Health freecall Public Health Information Line 1800 004 599.	Department of Health
	Transcripts of media interviews	Department of Health
	Streaming of press conferences and interviews	Department of Health
	Question and Answer sheets on Australian Government Department of Health website (www.health.gov.au)	Department of Health
	List of links to S/T HD and other key websites on Australian Government Department of Health website (www.health.gov.au)	Department of Health
	Access to information and advice from healthcare professionals through a national call centre.	National Health Call Centre Network
	Information will be posted on the Australian Government Department of Health website (www.health.gov.au)	Department of Health
	Information posted on S/T HD websites	S/T HD
return to business as usual	Key messages communicated to government health departments, border agencies and airports/airlines/seaports/shipping and cruise lines	Department of Health
	Key messages communicated to Local Government, NACCHO affiliates and jurisdictional industry peak bodies through identified email contacts for pandemic	S/T HD NACCHO

Attachment D. Decision Support Map

Major decision making points

This document highlights the major decisions to be made across the stages of the AHMPPI. As the key decision making body, these decisions will be made by AHPPC, in consultation with broader government and other stakeholders. Decisions will be based upon the capacity of actions to contribute positively to the AHMPPI's strategic objectives:

- Minimise transmission, morbidity and mortality;
- Minimise the burden on/ support health systems; and
- Inform, engage and empower the public.

To ensure that the appropriate expertise and implementation experience is available to support these decisions, relevant health advisory bodies, such as CDNA, PHLN or the Department of Health will provide AHPPC with a set of recommendations for its consideration.

The triggers used here will be identified through surveillance as outlined in the Surveillance Plan. CDNA will be responsible for advising AHPPC of the presence of any of these triggers.

Note: In this document the AHMPPI stage during which the decisions discussed will be made is indicated as a coloured bar on the side of each page (for e.g. the decision to move to the Standby stage will actually be made during the Preparedness stage and is represented as a green bar.)



Trigger: If surveillance indicates sustained community transmission of a **novel influenza virus overseas**, AHPPC will consider:

1. Should the AHMPPI be escalated to **Standby** stage?



If **NO**, continue to gather and review surveillance information

If **YES**, which measures should be commenced?

2. Should the disease be determined as an LHD under the *Biosecurity Act 2015*?
3. Should a declaration by the Governor General under the *Biosecurity Act 2015* be made to provide legal support for any measures?
4. What are the key communication messages to be conveyed? (Template provided at Attachment C of the AHMPPI.)

Background

Surveillance for novel viruses of concern is an ongoing 'normal business' activity undertaken by the Department of Health and state and territory health departments, with advice from WHO. While novel viruses are periodically identified, this identification is relevant to the AHMPPI only if it signals the need to prepare to mount an imminent response.

Escalation of the AHMPPI to Standby would signal commencement of a range of preparatory activities to

- confirm knowledge of current resources (human, stockpiles);
- plan potential reprioritization of resources (including surge staffing and alternate HR options);
- provide briefing to refresh knowledge of anticipated needs, governance, communications and arrangements;
- implement some measures (e.g. communications, NMS pre-deployment);
- confirm communications channels between responders; and
- build community preparedness and engagement.

Compliance with most measures by the individual will be implemented on a voluntary basis. Where the consequences of non-compliance are high however, it is possible to provide legislative support to the implementation of certain measures under the human biosecurity emergency powers of the *Biosecurity Act 2015* by the Minister for Health of either:

- declaring a ban or restriction on a behaviour or practice; or
- declaring a requirement for a behaviour or practice.

Communications will be central to many aspects of the response. The role of AHPPC in communications will be to establish the key messages to be conveyed to support the strategic objectives of the Plan. These will then be tailored to the needs of specific audiences and distributed by a range of stakeholders, with public communications coordinated through NHEMRN.

Trigger: If surveillance indicates the **first case of the novel virus has been identified in Australia**, AHPPC will consider:

1. How should the pandemic impact level be characterised, based on current evidence?
2. Should the AHMPPI be escalated to the **Initial Action** stage?



If **NO**, continue to gather and review surveillance information

If **YES**, should any modification of the initial measures proposed in the AHMPPI be made, given the current information available about the disease?



If **NO**, implement initial measures described in AHMPPI.

If **YES**, determine appropriate modifications and implement measures.

3. What recommendations regarding measures outside the health sector should be made? (e.g. school closures, transport, enhanced border measures)
4. What are the key communication messages to be conveyed at this stage? (Template provided at Attachment C of the AHMPPI.)

Background

At the beginning of the pandemic lack of information about the virus and how it will behave in the Australian context will make it difficult to characterise the impact it will have on the Australian community. Nevertheless there is likely to be pressure to do so to inform the public and to shape planning (including the decision about escalating the AHMPPI to the Initial Action stage). Information from overseas can be used to point to a certain level, but the uncertainty around the information should be acknowledged and review conducted regularly.

Escalation of the AHMPPI to Initial Action would signal commencement of a package of initial measures considered to be most likely to effectively meet the objectives of the AHMPPI in the absence of detailed knowledge of the disease. (Early information is likely to be insufficient to support planning.) As the consequences of aiming response efforts at too low a level of impact are significant, these measures are aimed at responding to a pandemic of moderate to high impact. At the time of the pandemic, if reliable information is available it should be used to confirm or modify these measures as appropriate. Initial measures would transition into measures more closely targeted to current needs more information becomes available.

The AHMPPI is focused on health sector activities. Some measures may need to be implemented in other sectors, on advice from health sector experts. The decision to make recommendation to other sectors will be made by AHPPC and input into Whole of Government channels.

Trigger: If advice from CDNA/PHLN indicates that information is now available about the disease which allows closer targeting of measures, **AHPPC** will consider:

1. Should characterisation of the pandemic impact level be modified?
2. Should the measures identified be modified (scaled up/ scaled down), wound down or ceased?
3. Should any new measures be commenced?
4. Have key communication messages changed?

Background

As more information becomes available about the virus and its impact in the Australian context, measures can be tailored more closely to meet current needs. This will allow us to

- implement a response proportionate to the risk;
- increase the effectiveness of the measures; and
- make the most efficient use of resources.

All measures should be reviewed regularly to ensure they are still contributing positively to the strategic objectives. It may be useful to set a regular time for review (frequency will depend on the progress of the pandemic), such as weekly, to assist building awareness of changes made. A suitable exit strategy should be considered for any measures being ceased.

Components of key communication messages may change at this point, as this trigger is likely to coincide with a change in focus of surveillance activities. Once the epidemiology, clinical severity and virology of the disease are understood, the benefits from enhanced data collection, to the extent envisaged in 'FF100 studies', are minimal (see Surveillance Plan for more detail). To continue enhanced activities on this scale would place an unsustainable burden on surveillance and laboratory systems. Some level of ongoing monitoring of epidemic behavior, however, is warranted to ensure that the response remains appropriate. Surveillance will return to routine activities and monitor for any changes in the situation that would impact on the public health response. The change in the information available will need to be managed carefully as there is likely to be a continuing demand for specific reporting, such as numbers of cases and deaths (preferably this should not be the emphasis of early stage reporting either, however this may be unavoidable.)

This trigger is likely to occur at a number of times as activities implemented in the Initial Action stage are reviewed. The transition from Initial Action to Targeted Action is not a hard cut off, but a gradual refinement of activities as more information about the disease becomes available.

Trigger: If surveillance indicates **widespread community transmission** is now occurring in Australia, **AHPPC** will consider:

1. Should resources be reallocated/ reprioritised to support increased demands for treatment/ increasing staff absenteeism?
2. Should actions aimed at minimizing entry into the community be wound down and ceased?(if applied)
3. What are the key communication messages to be conveyed at this stage? (Template provided at Attachment C of the AHMPPI.)

Background:

As transmission becomes widespread the emphasis of measures will move from identification to treatment. The pattern of demand may become such that existing arrangements can no longer cater for it. Reallocation and reprioritization of resources may be required. Staff absenteeism, due to either illness or the need to care for those who are ill, will impact on human resources. Increased absenteeism across the community is likely to cause increasing disruption to services and will need to be taken into account within health system planning (and across broader community planning). Some level of enhanced data collection will need to continue in order to fully understand the behaviour of the disease and to monitor for changes.

With widespread community transmission actions aimed at minimizing entry of the disease into the community are no longer of value. The demand for health services is likely to increase dramatically and resources should be allocated to supporting treatment rather than identification.

As transmission becomes widespread, measures will need to be examined for their appropriateness in the current level of pandemic. As resources become scarcer decisions will need to consider whether milder cases should be treated. For milder pandemics decisions will need to balance limiting of transmission with the disruption to society caused by isolation of ill individuals and quarantining of contacts.

Trigger: If advice from the Department of Health indicates that a **customised pandemic vaccine** will shortly be available, **AHPPC** will consider

1. Will distribution of the vaccine follow seasonal arrangements? Are other mechanisms required?
2. Do resources need to be reallocated/ reprioritised to support the vaccination program?
3. Will the vaccine be provided in stages?



If **YES**, which will be the priority groups?

4. Will any addition be required to existing arrangements for monitoring adverse events?
5. What are the key communication messages to be conveyed at this stage? (Template provided at Attachment C of the AHMPPI.)

Background:

The most effective way of preventing individual infection with an influenza virus is vaccination. The provision of a customised pandemic vaccine will be one of the goals of the response.

An assessment will need to be made regarding whether existing arrangements will be sufficient to meet the expected demand for vaccination. These may need to be supported by additional mechanisms. Depending on the nature of the pandemic, when a customised pandemic vaccine becomes available the demand may surpass the immediate availability. In this case while a range of potential priority groups can be predicted, based on seasonal influenza and past influenza pandemics, the actual priority groups will need to be finalised in the light of the epidemiology of the pandemic virus.

Implementation of a vaccine program will need to be accompanied by regular review of measures with an aim to winding down and ceasing any escalation beyond seasonal influenza arrangements.

Trigger: If advice from CDNA indicates that the **needs of the situation can be met by seasonal influenza arrangements and monitoring for change is in place, AHPPC** will consider:

1. Should the AHMPPI be scaled back to the **Standdown** stage?
2. Are there any current resource needs which require discussion?
3. Are there any key points/instructions to guide evaluation processes?
4. What are the key communication messages to be conveyed at this stage? (Template provided at Attachment C of the AHMPPI.)

Background:

Enhanced arrangements place an additional burden on health systems and individuals and should be scaled back when no longer necessary. The Standdown stage allows a supported withdrawal of enhanced arrangements. The evaluation of the response, and updating of/adaptation of systems, which is part of the Standdown stage ensures that as much as possible, the lessons from the pandemic can be applied to future outbreaks.

Resources at this stage may be considerably depleted and may still require some reprioritisation to meet demand.

Communications will be important as the response winds down to ensure that people continue to be aware of measures to protect themselves at an individual level, and to shape awareness such as the possibility of further outbreaks and the continuity into the following two to three years of seasonal influenza.

Trigger: If advice from the Department of Health indicates that **all escalated measures have ceased, AHPPC** to consider:

1. Should the AHMPPI be returned to the **Preparedness** stage?
2. What are the key communication messages to be conveyed at this stage? (Template provided at end of this document.)

Background:

It is likely that the health sector will continue to require support to enable services to “catch up” while recognising that the community may require additional services to enable full psychological, social, economic, environmental and physical recovery from the effects of the pandemic.

At some point the Department of Health will advise AHPPC that all enhanced measures have been transitioned to seasonal arrangements. Arrangements under the AHMPPI should then return to the **Preparedness** stage. The **Preparedness** stage represents ongoing activities under normal business arrangements which will support preparedness for any future pandemics. The return to **Preparedness** should acknowledge that **Recovery** activities may still be taking place within the health sector.

Attachment E. Introduction to the Menu of Actions Contents

Infection control measures

- Communication strategies to improve hand hygiene and cough/sneeze etiquette
- Personal protective equipment for healthcare providers, public health officials and other workers in direct contact with infected individuals
- Mask wearing by symptomatic individuals in the community

Border measures

- Communications measures:
 - Pandemic-specific inflight announcements and on-board announcements on ships
 - Communications materials for incoming or outgoing travellers
 - Travel advice regarding high-risk places and to raise awareness of symptoms if returning from travel
 - Information for border staff
- Identification measures:
 - Entry screening
 - o Negative pratique
 - o Passenger locator documents
 - o Thermal scanners
 - o Border nurses
 - o Screening of passengers on cruise ships prior to disembarkation, where there is evidence of cases of influenza on board
 - o Voluntary isolation of ill travellers not requiring hospitalisation
 - o Voluntary quarantine of contacts of ill travellers
 - Exit screening
- Internal travel restrictions

Social distancing measures

- Proactive school closure
- Reactive school closure
- Workplace closure
- Working from home
- Cancellation of mass gatherings
- Voluntary isolation of cases
- Voluntary quarantine of contacts
- Contact tracing

Pharmaceutical measures

- Antivirals for treatment of cases
- Antivirals for post-exposure prophylaxis for contacts
- Antivirals for post-exposure prophylaxis for contacts in at-risk groups
- Antivirals for pre-exposure prophylaxis for healthcare workers
- Candidate pandemic vaccine
- Customised pandemic vaccine
- Seasonal influenza vaccine

Measures of effectiveness

The following scale has been used in this document to describe effectiveness:

- high: an overall risk reduction of more than 50%
- moderate: a risk reduction between 10% and 50%
- minor: a risk reduction of less than 10%.

For some measures, it has been noted that no evidence is available.

The following scale has been used to describe economic impact:

- extreme: an impact in the order of hundreds of millions, or billions, of dollars
- high: an impact in the range of millions of dollars
- moderate: an impact in the range of hundreds of thousands of dollars
- minor: a smaller impact.

Direct costs have been defined as costs incurred in implementing or participating in measures, such as printing, distributing and storing brochures; or costs for staff to implement screening measures.

Indirect costs have been defined as flow-on costs incurred as a consequence of implementing or participating in measures, such as lost profits due to workplace closure, absenteeism from work for parents to look after children sent home as a result of school closures, and opportunity costs where resources could have been used elsewhere.

The tables in this menu of actions are based on evidence available in 2013. They will be updated periodically.

Menu of actions: infection control

The overall aim of infection control measures is to minimise the risk of exposure to the influenza virus, reducing transmission, infections and illness.

Effective infection control during a pandemic is best achieved by applying a combination of:

- Individual measures;
- Appropriate personal protective equipment (PPE); and
- Organisational and environmental measures.

Infection control measures will be essential in healthcare settings, but it may also be helpful to encourage individuals within the community to use certain measures to reduce their risk of exposure, or to reduce the likelihood of those with the disease transmitting it to others.

Modes of transmission of influenza

The types of infection control which should be applied are dictated by the mode of transmission of the disease. There is good evidence from outbreak investigations, interventional studies, experimental studies, animal studies and modelling to demonstrate that influenza is transmitted through contact (when hands, clothing or other objects become contaminated) and through droplets (where respiratory droplets are transferred to mucosal surfaces through coughing, sneezing or direct contact). The contribution of transmission through aerosols (when microorganisms remain infectious over time and distance when suspended in the air), and the circumstances under which this mode of transmission is important are still unclear. The importance of managing aerosol transmission is dependent on factors related to the virus, the individual and the environment. For example, specific procedures within the health care setting may increase the risk of aerosol transmission such as intubation and bronchoscopy.

Potential aerosol generating procedures are endotracheal intubation, nebulized medication administration, airway suctioning, bronchoscopy, diagnostic sputum induction, positive pressure ventilation via facemask, cardiopulmonary resuscitation and high frequency oscillatory ventilation.

To manage contact and droplet transmission the recommended infection control practices for influenza in Australia include:

- hand hygiene;
- respiratory hygiene and cough etiquette;
- gloves, gown and eye protection—to be worn when there is the potential of direct or indirect contact with blood or body substances;
- surgical mask; and
- patient placement—single room or cohorting, surgical mask when not in isolation.

When there is a high probability of airborne transmission additional infection control aspects which can be considered include:

- P2 respirators—these are designed to help reduce the wearer's respiratory exposure to airborne contaminants. For patients with influenza, this is practiced by the use of P2 respirators by healthcare workers when there is a significant risk of aerosol transmission, such as staff involved in bronchoscopy and intubation; and
- minimising exposure of staff and patients through patient placement and transfer.

Overseas approaches

Pandemic influenza documents on infection control by the WHO, Public Health England and US Centers for Disease Control and Prevention consistently highlight the importance of applying a package of infection control measures (administrative, engineering/environmental controls and PPE). WHO¹ and UK² documents recommend standard and droplet precautions for influenza viruses (for both sustained human to human transmission seasonal/pandemic flu and new influenza virus with no sustained human to human transmission), with the addition of airborne precautions for aerosol generating procedures. They recognise that if a severe infection risk is posed there may need to be an increased usage of respirators. The US CDC³ recommends respirator use for all close contact with patients in an influenza pandemic.

Building a package of infection control measures for pandemic influenza

The selection of appropriate infection control measures will be made by individual organisations and individuals. Within healthcare settings this should be guided by the *Australian guidelines for the prevention and control of infection in healthcare* (2010)¹ (the Infection control guidelines). These Guidelines outline the current evidence based recommendations for infection prevention and control practices in healthcare settings in Australia. Healthcare workers are familiar with these guidelines, and this will assist the appropriate implementation of practice in a potentially difficult and fast moving situation. When a pandemic occurs, the appropriateness of these practices to the current situation will be examined by CDNA and appropriate experts. Advice will be circulated widely among health professionals confirming the application of existing guidelines or highlighting any changes of approach recommended to best adapt to the current pandemic. Jurisdictions may also provide guidance on preferred approaches.

The summary tables which follow this introduction provide information on factors relevant and can be used to support decisions regarding the use of PPE by healthcare workers, public health officials and other workers in direct contact with infected (symptomatic) individuals.

The following information is also useful when considering which organisational measures should be implemented as part of an infection control package:

- Patient placement, flow and segregation are essential factors for hospitals, GP practices and other healthcare settings where influenza patients may be encountered.
- Early triaging and patient management can reduce the risk of transmission from influenza patients. Identifying suspected influenza patients (e.g. by telephone triage or self-identification), placing a surgical mask on them, and separating them quickly is important in reducing the spread.
- Systems can separate suspect and confirmed influenza patients throughout their interaction with healthcare. Designating separate sites, such as flu clinics or specific flu-designated GP clinics, to direct people with possible influenza is one method. Within settings, patient isolation and cohorting, is used to protect non-flu patients from flu patients. Separate staffing arrangements for flu and non-flu patients may also assist in protecting patients, as well as staff members at particular risk of influenza complications.
- Staff vaccination, including the use of candidate and customised pandemic vaccines where available, is important to consider and, if appropriate, encourage.

1 Infection prevention and control of epidemic- and pandemic-prone acute respiratory diseases in health care, WHO Interim guidelines, June 2007. http://apps.who.int/iris/bitstream/10665/69707/1/WHO_CDS_EPR_2007.6_eng.pdf

2 Infection control guidance for hospitals and primary care settings, UK Department of Health, 2009. <https://www.gov.uk/pandemic-flu>

3 Interim Guidance on Infection Control Measures for 2009 H1N1 Influenza in Healthcare Settings, US CDC, 2010.

Use by individuals

Infection control measures, such as hand hygiene, cough and sneeze etiquette, are also likely to be among the most effective measures which can be implemented by individuals within the community to manage their exposure to the disease, and that of those they care for. Communication campaigns implemented at a national or jurisdictional level, may be used to inform members of the public about these simple measures, which they may implement themselves. Healthcare professionals may also be asked to encourage certain behaviours among their patients. This is discussed further in the Communications Chapter.

The summary tables which follow this introduction provide information on the factors relevant to deciding whether to implement:

- Communication strategies to improve hand hygiene and cough/ sneeze etiquette; or
- Mask wearing by symptomatic individuals in the community.

This entry on communications strategies is focused on communication with the general public during a pandemic. Hand hygiene for healthcare workers is a standard component of normal practice and should comply with the Infection control guidelines.

Quality of evidence regarding the effectiveness of infection control measures

Good evidence about the effectiveness of infection control measures is lacking, although a number of recent studies have been supportive. Much of the available evidence indicating the effectiveness of improved hand washing in reducing infection, relates to healthcare settings and to diseases other than influenza.

Although work related influenza infection in healthcare settings is well documented, very few studies have been undertaken about the effectiveness of PPE in reducing infection. Many of the studies that have been conducted suffer from poor compliance, or lack power to detect an effect. The use of airborne precautions in an influenza pandemic situation, in particular the use of P2 respirators, has been discussed extensively. The evidence about the contribution of, and circumstances under which, aerosol transmission of pandemic influenza is unclear. There is also a lack of good evidence about the effectiveness of P2 respirators to reduce the transmission and development of influenza in contacts. The evidence does highlight that the effective use of P2 respirators requires it to be properly fitted and for individuals to be trained in the correct and safe use. In addition, P2 respirators are often uncomfortable to wear, particularly for those not used to these devices.

While the responsibilities and understanding of disease transmission of the general public will be different from that of healthcare workers, it is likely that the heightened concern associated with a pandemic will motivate the public to engage in infection control measures. Providing the public with measures to that they can apply to reduce their own risk of infection will benefit public confidence.

Information regarding the effectiveness of communication strategies in changing hygiene behaviours is available but sparse.

Use of infection control measures in AHMPPI stages

Hand and respiratory hygiene, and cough etiquette should be followed across all AHMPPI stages, unless advice is provided indicating new practices are needed for the current pandemic. Similarly, hand hygiene and use of PPE by healthcare workers should follow the standard approach set out in the Infection control guidelines. Should emerging evidence show the virus to be causing severe infection risks, the use of airborne precautions may need to be re-examined.

Early and timely identification, triage and separation of potential cases will promote most effective infection control. Effective use of surgical masks for patients should be considered in all stages. In the Initial Action stage triage and separation of potential cases will be important. As more becomes known about the virus during

the Targeted Action stage, when clinical severity is higher measures such as telephone triage, cohorting, and possibly alternate clinical care models which allow greater separation will become more important.

Staff who are sick should be encouraged to stay home in all stages and vulnerable staff should be protected by using appropriate PPE, or where clinical severity is higher isolated from exposure to settings where there is a risk of exposure.

Standard methods of environmental cleaning are appropriate across all stages. Open environments, such as outside clinics, verandahs and open doors/windows may be considered during the Initial Action stage and used when possible during the Targeted Action stage if clinical severity is higher.

IC1: Communication strategies to improve public hand hygiene and cough/sneeze etiquette (recommendations to avoid mass gatherings may also be included)

Application

Recommended. This measure is easy to implement and provides the public with a method of reducing their individual risk. Some studies have shown a benefit in community settings if hand washing is practised frequently.

Objective and rationale

To limit community spread of the virus by reducing the risk of exposure.

Effectiveness

Minor to moderate. There is currently a lack of good evidence in this area. It is unlikely infection control measures will significantly affect overall pandemic attack rates unless disease transmissibility is low, compliance with the measure by the majority of the population is high, and the measure is used in association with other mitigation strategies. However, a number of studies point to the value of this measure in reducing individual risk.

Alcohol-based hand sanitisers have been shown to be effective in schools in reducing the incidence of gastrointestinal and respiratory diseases.² A study conducted in Hong Kong found that hand hygiene seemed to prevent household transmission of influenza virus when implemented within 36 hours of onset of symptoms in the index patient.³ Clinical trials conducted in Finland concluded that intensified hand hygiene using water and soap, together with behavioural recommendations, can reduce the occurrence of self-reported acute illnesses in common work environments.⁴

There is a considerable evidence to support the positive impact of media campaigns on health-related behaviours². Information and evidence on hand hygiene is available in the WHO Guidelines on hand hygiene at http://whqlibdoc.who.int/publications/2009/9789241597906_eng.pdf

Risks and benefits

Risks: Use of alcohol-based hand sanitiser may cause dermatitis in some individuals, which could prolong the viability of infective agents.

Benefits: This measure will reduce the risk of exposure to the virus, with a high potential benefit to the individual. It may reduce microorganisms in the air. When disease clinical severity is low, the greatest benefit will be for high-risk individuals. Increased confidence in the general public is likely, arising from the capacity to take steps to manage their own risk. Infection control measures can be started quickly and without specific knowledge of the respiratory agent.

Direct costs

Minor to moderate. Costs include those associated with purchase of hand sanitiser, cleaning agents and tissues; development and printing of posters and advertisements; advertising time; and disposal of significant amounts of contaminated paper.

Secondary costs

Nil

Likely acceptability and expectations

Acceptability will be highest if the disease is perceived to be severe. A hand hygiene program with provision of alcohol-based hand sanitiser in an office work environment was found to be acceptable and to increase hand washing in Germany,⁵ but no research is currently available for the Australian population/context. Respiratory hygiene advice has been used as part of seasonal and pandemic H1N1 2009 influenza campaigns.

Practicalities and experience

To increase the frequency with which people wash their hands, individuals will require easily accessible facilities. As availability of hand washing facilities is often limited, alcohol-based hand sanitiser will often be the best way to support increased hand washing.

This is a simple measure that can easily be adopted by the public. Adequate stocks of hand sanitiser would be required. It will be important to ensure that media campaigns build on seasonal influenza programs and are developed in collaboration with higher risk groups and vulnerable populations.

Timing

This measure should be commenced early. Community benefits will decrease as transmission becomes widespread, but benefits for the individual will continue to warrant use of this measure until the end of the pandemic.

IC2: Personal protective equipment (PPE) for healthcare workers, public health officials and other workers in direct contact with infected (symptomatic) individuals

Application

Use should be **based on risk** of transmission of infectious agents and risk of contamination of clothing or skin. PPE should be used as part of a package of infection control measures, as described in the *Australian guidelines for the prevention and control of infection in healthcare* (2010) (infection control guidelines).¹

Objective and rationale

To reduce transmission from infected persons to staff members in higher risk settings.

Effectiveness

Moderate. Although work-related influenza infection is well documented (e.g. Kuster et al.)⁶, very few studies have been undertaken about the effectiveness of PPE in reducing infection. Many of the studies that have been conducted suffer from poor compliance or lack the power to detect an effect.

Whether surgical masks or respirators should be recommended for routine patient care in healthcare settings, and for general use in the community is not clear, given the lack of evidence supporting one type of mask over the other and uncertainties about the predominant modes of influenza transmission. The evidence highlights that incorrect technique for wearing PPE is common. Effective use of P2 respirators requires them to be properly fitted and for individuals to be trained in their correct and safe use.

Current practice includes use of PPE as part of contact and droplet infection control recommendations (see infection control guidelines¹).

There is little evidence available to demonstrate transmission of influenza to border workers. Although such transmission is possible, the level of contact with infected cases is likely to be much lower for border workers than for healthcare workers.

Risks and benefits

Risks: Inappropriate use of PPE may reduce effectiveness. Education on appropriate use of masks would be required to ensure that there are no unintended negative effects of mask wearing, or increased indirect transmission through constant touching and adjusting of wet masks. Staff should be well trained in the appropriate donning, removal and disposal of PPE.

Benefits: This measure can be started quickly and without specific knowledge of the respiratory agent. It allows people to continue to work while giving them some protection. It is likely to build confidence and decrease absenteeism. This measure may reduce transmission. When disease clinical severity is low, the greatest benefit will be to high-risk individuals. Protection of healthcare workers from infection is an important part of OH&S, and in the pandemic setting, important to maintain the health workforce, particularly the specialised health workforce such as Intensive Care Unit (ICU) staff. Use of PPE may help to minimise the use of antivirals.

Direct costs

Depending on the scope of the measure used, the clinical severity and transmissibility of the pandemic, costs could range from minor to high. Costs would include purchasing, storing, stockpiling, distributing and disposing of PPE.

Secondary costs

Minor to moderate. The use of some types of PPE can affect the speed of work being undertaken by staff and therefore their productivity (e.g. through time taken to don and remove PPE, and increased time required for routine clinical tasks). There will also be costs associated with educating staff on use of PPE.

Likely acceptability and expectations

Good. Use of PPE is well established in healthcare settings and generally supported by healthcare workers. The difficulty and discomfort of working while wearing PPE may lead to poor compliance; compliance is likely to be higher with a disease of higher clinical severity.

Practicalities and experience

Wherever possible, use of PPE should be consistent with use for seasonal influenza and the Infection control guidelines.¹ Sufficient quantities of PPE and facilities for its disposal will need to be available. Simple guidelines for when PPE should be used, and education campaigns to communicate appropriate use and disposal of PPE will be needed. If respirators are used, they will need to be properly fit checked for each staff member and available in appropriate sizes. Respirators may be difficult to wear for extended periods. Special arrangements may need to be made to ensure sufficient availability in remote and vulnerable communities.

Timing

This measure must be used from the first patient contact. There is a case for wider use of PPE early in the pandemic, when the clinical severity of the disease may not be well known. Benefits would continue throughout the pandemic.

IC3: Mask wearing by symptomatic individuals in the community

Application

This measure may be **considered by individuals** when the disease has a high clinical severity.

Objective and rationale

To reduce transmission within the broader community.

Effectiveness

No evidence. Very few studies have been undertaken about the effectiveness of PPE in reducing infection in the community. Modelling studies of widespread PPE use suggest that mask use could reduce population transmission, although estimates of effectiveness are limited by the quality of data on individual effects. There is evidence from both clinical and modelling studies that earlier initiation of PPE improves its effectiveness.

The evidence highlights that incorrect technique for wearing PPE is common. Mask wearing in the community is unlikely to affect overall attack rates from a pandemic unless disease transmissibility is low, compliance with the measure by the majority of the population is high, and the measure is used in association with other pandemic mitigation strategies.

Risks and benefits

Risks: Inappropriate use of masks may reduce effectiveness. Education on appropriate use of masks would be required to ensure there are no unintended negative effects of mask wearing, such as decreased compliance with social distancing measures (self-isolation) because people feel protected, or increased indirect transmission through constant touching and adjusting of wet masks. Stigmatisation of people wearing masks is possible.

Benefits: This measure may reduce the exposure of individuals' household and family members to infection. It can be started quickly and without specific knowledge of the respiratory agent. It may reduce transmission.

Direct costs

High. Costs would include purchasing, storing, stockpiling, distributing and disposing of masks. A system would need to be implemented to make masks accessible at short notice, so that they could be worn from the onset of symptoms.

Secondary costs

Minor to moderate. Mask wearing in the community would need to be supported by educational materials. Costs would depend on the type of materials used (e.g. posters, leaflets, internet, advertising).

Likely acceptability and expectations

Poor compliance is likely. It is particularly difficult to keep masks on young children.

Practicalities and experience

This type of measure would need to be supported by an education campaign on both use and disposal of masks, and by provision of advice from healthcare workers, particularly GPs. Sufficient quantities of masks and facilities for disposal would also need to be available. People with respiratory disease may find it difficult to wear a mask continuously.

Timing

There is a case for wider use of masks early in the pandemic, when the clinical severity of the disease may not be well known. Early application offers the greatest opportunity to reduce transmission, although benefits would continue throughout the pandemic. This measure would require the population to recognise the early signs and symptoms of influenza, and to already possess or have prompt access to masks. In the early stages of the pandemic, public health authorities may be able to coordinate mask distribution to cases; however, distribution systems are likely to be overwhelmed as the pandemic spreads. As more information on the virus becomes available, it is possible that use of masks could be scaled back to a more sustainable and evidence-based level.

Menu of actions: border measures

Border measures include a range of measures that can be taken at airports and seaports to delay the entry or minimise the spread of illness to or from affected countries (or jurisdictions).

Australia's large land mass, large number of entry/exit points and frequent international travel means that it is highly unlikely that border measures would be effective in delaying the entry of pandemic influenza into Australia for a length of time that has practical relevance. Research consistently concludes that even with very rigorous restrictions on air travel, a delay of only two weeks could be achieved. Furthermore, in 2009, the pandemic virus had already spread widely before international authorities were alerted, suggesting that the point of emergence and opportunity to stop entry into countries had been missed by several weeks.

Australia's border measures will therefore aim to minimise transmission of the disease into the Australian community.

Public health measures related to communicable diseases of concern are in place at Australia's borders every day. In circumstances where a new or changing public health risk arises, such as an influenza pandemic, a range of options exist to strengthen these measures. The potential public health benefit of these options depends on the characteristics of the virus and disease, the behaviour and extent of spread internationally, and practicalities of implementation.

In selecting the most appropriate border measures for use during an influenza pandemic, it is important to have an understanding of the full suite of public health actions being used to reduce the spread of the disease across the Australian community. In Australia there is a comprehensive and well-resourced public health system that is able to detect and manage those with the disease and their contacts at multiple points in the healthcare system. Border measures should be selected to complement this public health response in the most efficient and effective way to ensure that the public health action is maximised. In countries with a less comprehensive public health system, the suite of public health actions to reduce the spread of communicable disease may be quite limited and border measures may play a different role in their response.

Border measures fall into the two main categories of communications and case identification (identifying and managing cases at the border).

Communications

Communications during situations of high risk or concern are an effective and efficient way to provide essential knowledge and engage key stakeholders, including the public, in the appropriate management of the situation.

Early in the response to a communicable disease threat, when the disease exists only (or principally) overseas, travellers are the group most likely to have been exposed to, and hence to be at risk, from the disease.

Therefore, communication with travellers at the border is an essential component of the response.

A crucial aim of these communications is to build and maintain the trust and confidence of travellers and the general public, by providing clear, concise, honest, realistic and timely information. This will promote the adoption of public health behaviours by travellers which will reduce transmission. These include the practice of hygiene measures, and awareness by individuals of when they may have influenza and of the need to present to health care early. Early presentation promotes early diagnosis and management and advice received can reduce behaviours that promote transmission, such as discouraging socialising with others when sick.

The key goals and messages at the border will be to:

- inform the public of the disease (symptoms and signs, how it is transmitted),
- provide guidance on appropriate responses (hand and respiratory hygiene measures, what to do, who to approach and where to go if symptoms are present), and
- address concerns (provide an accurate assessment of risk while acknowledging uncertainty and reassuring the travelling public that there are people who can help).

Multiple communication methods will be used comprising written, verbal and visual tools. This may include inflight announcements, posters/banners, brochures/pamphlets, electronic displays, social media messages for travellers and education of personnel at airports/seaports to whom travellers can ask questions.

Measures that effectively inform travellers can continue to be useful beyond the audience at the border.

Travellers entering or residents returning to our community after travel will circulate advice and reassurance at a community level about appropriate actions and management of the disease threat.

The summary tables which follow this introduction provide detailed information on the factors relevant to deciding whether to implement the following communication measures:

- In-flight announcements/On-board announcements (ships);
- Distribution of communications materials;
- Travel advice regarding high risk places and to raise awareness of symptoms; and
- Information for border staff.

Below is a flow chart outlining how communications measures at the border for pandemic influenza could be implemented.

Figure 8: Implementation of communication measures at the border.

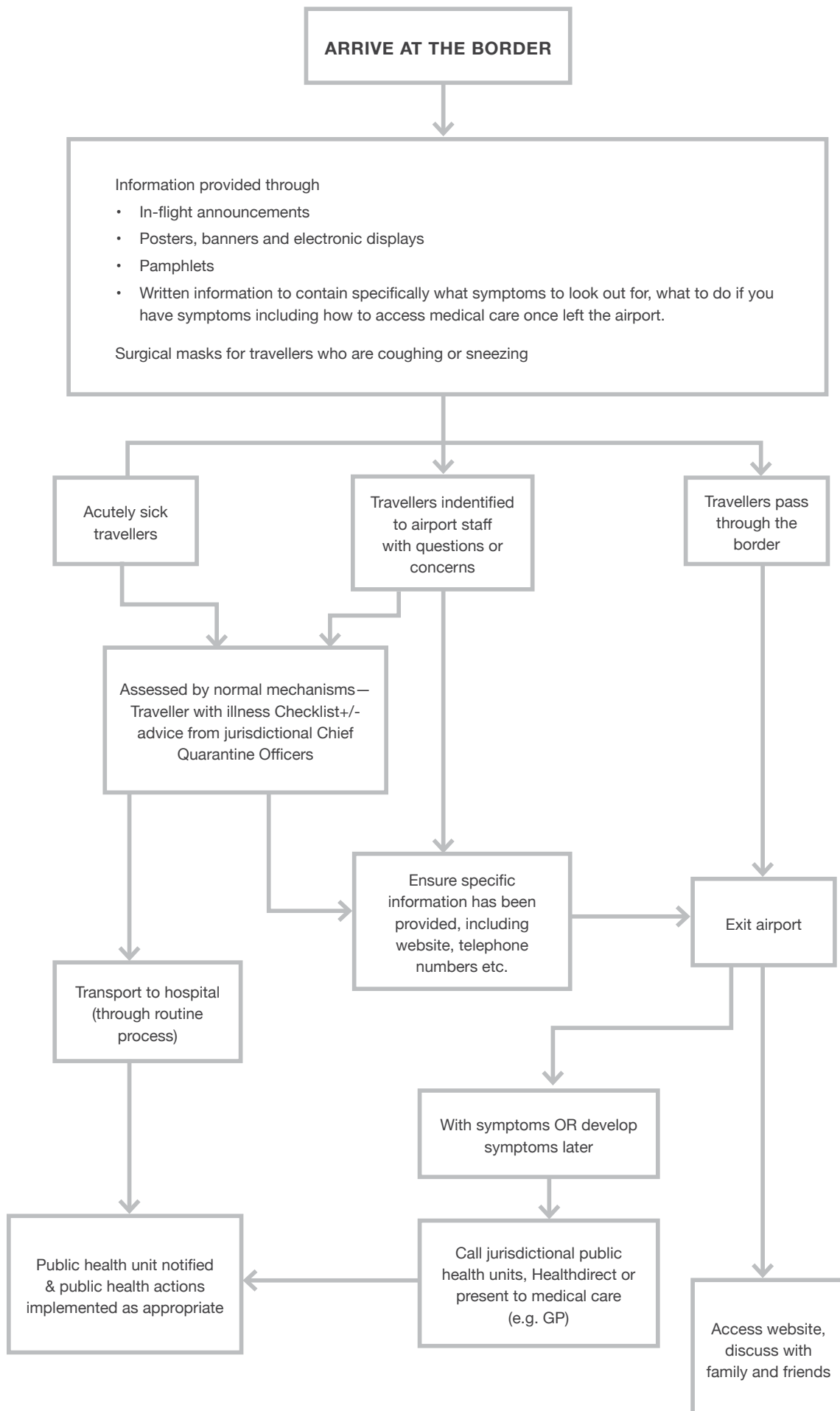

Case identification

Mechanisms exist at all times to assess and manage acutely sick travellers who require immediate medical care at the border. This may include transportation to a nearby medical facility with the oversight and advice of biosecurity officials and the relevant CHBO.

Additional screening methods such as Passenger Locator documents can be used to try to identify more cases of communicable disease prior to their entry into the community, in order to minimise disease transmission. These measures attempt to identify cases by asking questions about symptoms,. Implementation of screening measures is likely to require additional resources from both the Australian Government and from state/territory health sectors (border nurses) to conduct the screening, and triage and assess those who are identified through the screening process.

Overall effectiveness

There is limited direct evidence for the effectiveness of communications measures at the border in significantly influencing transmission of the disease. However broader evidence supports the value of communications campaigns in promoting behaviours which reduce risks to health at an individual level (including risks to border staff) and building community confidence.

The effectiveness of screening measures (case identification) varies according to the disease. To be effective the following criteria need to be met:

- The proposed screening test is highly sensitive, and reasonably specific relative to other similar acute respiratory illnesses; and
- A high proportion of infectious patients are symptomatic at the time of presentation at the border.

Influenza would not typically satisfy these criteria. In influenza infections the symptoms and signs of the disease are found in other common illnesses such as the common cold and other respiratory viruses and bacterial infections. This means many people will be picked up by screening who do not have the specific disease. Furthermore, some persons infected with influenza will still be in the incubation period, some will be shedding virus asymptotically, may have mild symptoms, or have taken analgesics which will reduce their temperature, and therefore not be identified by the screening methods. Therefore employing screening measures for influenza and other respiratory conditions are likely to identify many more people without influenza than with it (low specificity), and miss people who may continue to spread the infection (low sensitivity).

Evidence suggests that the ability of border measures to identify cases is limited. During the pandemic (H1N1) 2009 of the 15,457 travellers who were identified at the Australian border as being unwell, only 154 (1%) were managed as influenza after further investigation. Of 1287 passengers identified at Sydney airport through entry screening measures, only 3 (0.3%) were confirmed as cases.⁷

Even though the nature of SARS makes it more suited to use of border measures, experience from the SARS outbreak also showed that entry and exit screening was quite ineffective in preventing spread.⁸ Of the 1.84 million arrivals screened for SARS at the border when entering Australia in April–June 2003, only 4 arrivals met the case definition when investigated further.⁷

As the nature of the influenza virus makes it difficult to achieve any practically useful delay in transmission through active screening border measures, the focus of border measures in this plan will be on minimising the spread of the virus through the use of communications. Active screening measures for case identification, such as thermal scanners and Passenger Locator documents, are an ineffective and inefficient use of resources for the purposes of reducing transmission of respiratory viruses.

The exact nature of an influenza pandemic cannot be predicted. To ensure that information is available to support consideration of a full range of measures, in addition to communication measures, the summary tables which follow this introduction provide information on the factors relevant to deciding whether to recommend implementing the following case identification measures:

- Entry Screening:
 - Negative pratique
 - Passenger locator documents
 - Thermal scanners
 - Border nurses
 - Screening of passengers on cruise ships prior to disembarkation, where there is evidence of cases of influenza on board
 - Voluntary isolation of ill travellers not requiring hospitalisation
 - Quarantine of contacts at the border
- Exit screening
- Internal travel restrictions

Quality of evidence

Overall, the quality of the evidence available about the effectiveness of border measures is low. The majority is based on mathematical modelling and observational studies. There are few analytical studies. There was very limited published information about some of the measures, and none were considered in isolation.

Reference is made in this Menu to some literature in which SARS-related border measures were described or evaluated. It should be noted that there are limitations to extrapolating the experiences with SARS to pandemic influenza. Key factors in the success in controlling SARS (through case isolation, contact tracing and quarantine of contacts) were that cases of SARS are not infective during the incubation period, and that infectivity seems to peak 5 to 10 days after symptoms occur and asymptomatic cases did not seem to transmit the infection. Neither of these two factors applies to influenza⁹, and therefore any success with border measures during SARS may not be replicated during an influenza pandemic.

B1: Pandemic-specific inflight announcements and on-board announcements on ships

Application
Recommended as part of a communications package.
Objective and rationale
To encourage prompt presentation and diagnosis by raising travellers' awareness of signs and symptoms; encouraging presentation to a GP if symptoms are present; encouraging people to advise their GP of having travelled recently (and their destination). To reduce the burden of disease by encouraging early effective treatment.
Effectiveness
There is currently little direct evidence about the effectiveness of communications activities directed towards travellers. However, as part of a communications package, it could be a valuable tool for reaching people with an increased likelihood of exposure to the disease. In the 2009 pandemic review, travellers identified inflight announcements as the second most effective form of communication at the border for raising awareness of the disease.
Risks and benefits
<i>Risks:</i> Inflight announcements could raise concern in travellers about their safety in Australia and lead to travellers presenting unnecessarily at GPs as a result of anxiety. Identified services need to be available and accessible to avoid loss of confidence in authorities.
<i>Benefits:</i> This measure has broad coverage. Issue by the Australian Government of a standard message would promote consistent communications by all airlines and shipping lines. This measure provides an opportunity to raise awareness of signs and symptoms of the disease before people enter Australia and to raise awareness of public health interventions. It also informs travellers of the status of the disease in Australia. It would bring travellers up to date with community messages already provided within Australia.
Direct costs
Minor. Costs include translation of the messages to other languages and distribution of announcements to airlines and shipping agents (human resources time).
Secondary costs
Minor. A short amount of aircrew time would be required.
Likely acceptability and expectations
High. This measure would have minimal impost, and the public appreciates being informed.
Practicalities and experience
Support would be required to liaise with airlines and shipping agents and to respond to their requests to adapt centrally distributed announcements. Early in the pandemic, when the number of cases in Australia is very small, this measure would raise awareness in a group (travellers) that is more likely to have had exposure to the disease.
Communications activities for incoming travellers that encourage early presentation to a medical facility for moderate to severe influenza-like illness should be seen as part of the provision of clinical care for the entire Australian community. Clinical care services have the potential to reduce mortality and morbidity, and border measures can be useful as a referral mechanism for mainstream clinical services.
Timing
This measure should commence when notified of sustained human to human transmission of a novel virus. To be effective in reducing entry of the disease into the community, this measure would need to be used early; however, as a tool to raise awareness and update incoming travellers on the status of the disease in Australia, it would be useful throughout the pandemic. Announcements should change as the status of the disease within Australia changes and cease when seasonal influenza levels are reached.

B2: Communications materials for incoming or outgoing travellers

Application

Recommended as part of a communications package.

Objective and rationale

To encourage rapid presentation and diagnosis by raising travellers' awareness of signs and symptoms; encouraging presentation to a GP if symptoms are present; encouraging people to advise their GP of having travelled recently (and their destination); to inform of personal protective measures, such as hygiene.

Effectiveness

Evidence suggests this measure may have a *minor* effect in preventing overall transmission (as the number of infections likely to be prevented is small compared with the total number of infections across the community). However, as part of a communications package, this is a valuable tool for reaching people with an increased likelihood of exposure to the disease. During the pandemic (H1N1) 2009, 89% of individuals identified for assessment at Sydney airport self-identified after receiving health declaration cards—an example of information to raise the awareness of incoming travellers.¹⁰ Analytical studies of the effectiveness of risk communication on reduction of transmission are not available.

Risks and benefits

Risks: Materials printed in hardcopy can become out of date as the pandemic changes and understanding of the disease develops. Social media allows for rapid updating of information but not all travellers are users of social media and therefore may not be reached.

Benefits: This measure empowers travellers to take action. Printed materials can be easily put into a wallet to keep for later reference, and electronic messages can be checked via social media. The use of electronic displays at airports and social media allows for key messages to be updated as the situation changes. Key contact numbers can be communicated. Translated versions of communication materials will ensure wider accessibility and to take into account the cultural diversity of the Australian community.

Direct costs

Minor to moderate. Costs could include design, translation, printing, storage, and distribution and display of printed materials. For electronic messages, costs could include display screen purchases or message display fees (e.g. on doctor surgery or travel agent screens). (Costs will depend on the type of materials selected.) The use of social media has no direct cost if developed and monitored in-house.

Secondary costs

Minor. Costs will include the time taken to distribute and store materials, and to update/remove/destroy them once they are out of date.

Likely acceptability and expectations

High. There is minimal impost and no delay to travellers. Materials could be handed out at the same time as other entry documents. The expectation of the distributing agency would be that minimal time would be required to distribute materials.

Practicalities and experience

It would be better not to print too many materials early in the course of the pandemic, as the message may change through the course of the outbreak. Communications activities for incoming travellers that encourage early presentation to a medical facility for moderate to severe influenza-like illness should be seen as part of the provision of clinical care for the entire Australian community. Clinical care services have the potential to reduce mortality and morbidity, and border measures can be useful as a referral mechanism for mainstream clinical services. There may be some delay in provision of hard copy materials, such as pamphlets or posters, due to printing and distribution requirements. Design templates for printed and electronic messages could be created during the **Preparedness** stage to minimise the time for provision in later stages. Liaising with airports/seaports about appropriate channels to display information for travellers at individual ports should also be considered during the **Preparedness** stage. The use of existing social media trending tags (e.g. #pandemicflu) may assist in maximising the reach of social media messages.

Timing

This measure should commence when notified of sustained human to human transmission of a novel virus. To be effective in reducing entry of the disease into the community, this measure would need to be used early; however, as a tool to raise awareness and update incoming travellers on the status of the disease in Australia, it would be useful throughout the pandemic.

B3: Travel advice regarding high-risk locations and to raise awareness of symptoms if returning from travel

Application

Recommended as part of a communications package.

Objective and rationale

To reduce the number of Australians exposed to infection through travel to high risk locations by communicating the disease risks. To avoid exposure of Australians to infection who will then return and bring the disease back into the country. To reduce transmission, morbidity and mortality of those who do travel by raising awareness of symptoms and encouraging prompt presentation for medical assistance.

Effectiveness

Minor. Modelling studies suggest that travel advice to avoid high-risk areas has only a small effect on stopping the international spread of a pandemic unless adherence is close to 100%, although there may be a small delaying effect.¹¹ However, raising awareness of symptoms and how to access medical advice should lead to prompt presentation. Prompt presentation to medical assistance can provide people with strategies and resources to minimise transmission, and early intervention, which can minimise morbidity and mortality.

Risks and benefits

Risks: Potential perceived liability issues may arise from cancelling of travel. Many people may travel regardless of the advice.

Benefits: 'Provides Australians with information about overseas disease risks to enable them to make an informed decision about whether or not to travel.

Direct costs

Minor, but moderate if an advertisement is produced (leading to costs of developing the advertisement and obtaining screening time).

Secondary costs

Moderate. Diplomatic tensions may arise from discouraging travel to specific countries.

Likely acceptability and expectations

The Australian public expects to be informed of high-risk destinations. People in nominated countries may wish to depart and may expect assistance from the Australian Government.

Practicalities and experience

Experience from the SARS outbreak was that the number of international travellers to affected areas declined in advance of formal travel advice. Systems already exist for providing advice about high-risk destinations (Smartraveller – www.smartraveller.gov.au).

Timing

This measure should commence when notified of sustained human to human transmission of a novel virus. To be effective in reducing entry of the disease into the community, this measure would need to be used early; however, as a tool to raise awareness and update incoming travellers on the status of the disease in Australia, it would be useful throughout the pandemic. Announcements should change as the status of the disease within Australia changes and cease when seasonal influenza levels are reached.

B4: Information for border staff

Application
Strongly recommended .
Objective and rationale
To reduce the risk of transmission of influenza to staff through education and information about the risks of contact with infected persons. To reduce levels of concern amongst staff.
Effectiveness
There is <i>no direct evidence</i> of the effectiveness of this measure. Education of healthcare workers on hospital infection control measures has shown some effectiveness. This measure could be seen as a necessary component of good staff management.
Risks and benefits
<i>Risks:</i> The measure could raise concern in some staff about their safety when dealing with travellers. Any support services identified need to be available and accessible early to avoid loss of confidence in support systems. <i>Benefits:</i> Reduced transmission and reduced concern are likely to lower staff absenteeism. The measure provides an opportunity to raise awareness of signs and symptoms of the disease and of public health interventions, such as hand washing. It would keep staff informed about the status of the disease in Australia and the current response approach and priorities. It would also increase the feeling of inclusiveness of staff in response efforts as a whole.
Direct costs
Minor. Exact costs would depend on the mode of communication used, but could include printing, distribution and storage costs.
Secondary costs
Minor. Costs include administration costs.
Likely acceptability and expectations
High. This measure would have minimal impact, and the public appreciates being informed.
Practicalities and experience
This measure may produce the need to provide secondary support systems, such as access to medical advice or PPE. Information will need to be tailored to staff needs to promote confidence. Staff concerns are common in epidemic situations, reflected in requests for healthcare coverage in the United States, and access to PPE in Australia.
Timing
This measure should commence when notified of sustained human to human transmission of a novel virus. It will be important to update staff throughout the pandemic. Information should change with changes in the status of the disease within Australia and the response. The measure should cease when seasonal influenza levels are reached.

B5: Negative pratique (aircraft commanders must report the health status of passengers on board before landing, rather than the normal reporting by exception)

Application

Recommended only when asymptomatic carriage is unlikely. **Not recommended** once community transmission is established.

Objective and rationale

To detect infected incoming travellers in order to prevent on-going transmission.

Effectiveness

Minor. As asymptomatic individuals will not be identified under negative pratique, this measure is likely to be ineffective in preventing or delaying disease entry.¹¹ Effectiveness is further reduced as this measure relies on crew members noticing that someone is ill and making a decision to report it (this is unenforced). The measure is not effective without further case management.

Negative pratique was implemented in Australia on aircraft and cruise ships for influenza in 2009. Of the 15 457 travellers identified at the border as being unwell, 2011 (13%) were identified through this measure, though the number of actual cases was small. (See comments on overall effectiveness at front of the border measures menu.)

Risks and benefits

Risks: Large numbers of asymptomatic travellers will still bring the disease into Australia while the border measures have created a false sense of security. Airlines may not report illness, to avoid being delayed or associated with illness. Implementation could be complex, as it requires efficient coordination between pilots, handling agents and Australian Government Department of Agriculture to avoid delays to passengers. Resourcing could also be challenging in larger airports.

Benefits: The measure is easy to implement. It simply extends an existing system, raises airlines' awareness of the need to report ill travellers and identifies a proportion of ill travellers.

Direct costs

High, if the cost of investigation and management of individuals detected is included. This measure results in additional work for staff from the Australian Government Department of Agriculture staff as they must take a larger number of calls and arrange pratique (not normally required for all aircraft and ships).

Secondary costs

High. Implementing the negative pratique process and interviewing ill travellers could delay vessel turnaround. Management of identified ill travellers may require use of biosecurity officials and state health resources (if medical resources are stationed at airports and seaports). These resources are likely to be better used elsewhere during a pandemic, particularly as transmission within the community increases. Costs of delays in travel for individuals identified for follow-up may be substantial. Minor legislative change would be required to implement this measure.

Likely acceptability and expectations

High. This measure is an extension of an existing system that is regularly used. Experience from the SARS outbreak and pandemic (H1N1) 2009 suggests that there will be a public expectation of entry screening in some form. Decisions not to do so should be supported by information provided to the public and decision makers. There will be an expectation that the process is completed efficiently to minimise delays.

Practicalities and experience

During the response to pandemic (H1N1) 2009, limiting negative pratique to high-risk countries was considered. However, this was impractical as most flights into Australia pass through large international hubs before arriving in Australia, so it would be difficult to target the original destinations. It was also impractical for Department of Agriculture workforce planning, as border staff would need to manage different processes for aircraft from different locations. During normal business times, regular reports indicate under-reporting of ill travellers. (This may or may not be relevant during a pandemic. Experience from 2009 showed good reporting compliance.)

Timing

This measure should commence when notified of sustained human to human transmission of a novel virus. It must be used early to be effective, since its primary aim is to limit the entry of the disease into the community. The measure would cease when community transmission is well established.

B6: Passenger locator documents, such as the health declaration cards (HDCs) used during pandemic (H1N1) 2009 or International Civil Aviation Organization (ICAO) Passenger Locator Forms (PLFs)

Application

Recommended only when asymptomatic carriage is unlikely. **Not recommended** once community transmission is established.

Objective and rationale

To detect infected incoming travellers so that on-going transmission can be prevented; to encourage self-reporting by ill travellers; to raise awareness of the disease and provide information for use in contact tracing.

Effectiveness

For detection of cases: Minor. The measure cannot detect asymptomatic cases, and large numbers of asymptomatic travellers will still bring the disease into Australia. A small-scale pilot study in New Zealand of HDCs reported a voluntary response rate of only 57%, of whom 15% reported symptoms consistent with influenza-like illness. Of 1.2 million HDCs distributed to incoming passengers in Canada, none identified cases of SARS. During pandemic (H1N1) 2009 in Australia, 13 000 travellers with symptoms were identified through information provided on HDCs and underwent further assessment; of these, only 154 were managed as influenza.

To be effective in reducing transmission this measure requires case management of identified individuals.

For awareness raising: There is *no evidence* on whether passenger locator documents raise awareness of the disease, but they could potentially be another source of information.

Risks and benefits

Risks: Ill travellers may not provide accurate or legible assessments of their health or details. Border measures may create a false sense of security. HDCs do not include seat numbers, so cannot be used for contact tracing.

Benefits: Self-reporting identifies people who are feeling unwell when this may not be noticeable to others. One benefit of PLFs is that they are universally available and managed by ICAO, thereby giving a consistent message with no impost on Australia to manage design. They include seat numbers for contact tracing and do not requiring professional printing. One form for all countries is easier for airlines and shipping agents to store, manage and distribute. Use of PLFs rather than country-specific cards contributes to a consistent international response.

Direct costs

Moderate to high. Costs include medical resources and testing processes (if deployed at the border); printing (lower costs than for HDCs as no design work is needed); distribution to airlines and shipping agents; storage and distribution by airlines and shipping agents; collection, collation and analysis of the forms (e.g. HR resources, transport, scanning software, associated service provider); and storage of completed forms. If the forms are being used for contact tracing, a system is required for rapid data entry so that details are available to public health authorities in a timely manner. Staff required to take those reporting symptoms to further action.

Secondary costs

High. Costs include liaison with airlines and shipping agents regarding use of the forms, and opportunity costs if medical resources are deployed at the border.

Likely acceptability and expectations

High. There is a minor time inconvenience to passengers to complete the form and some administrative burden on airline and ship crews. As HDCs have been used before, there will be some existing acceptability and expectation of use of the forms. Experience from SARS and pandemic (H1N1) 2009 shows that there may be a public expectation of entry screening in some form. Decisions not to do so should be supported by information provided to the public and decision makers. Guidelines for filling in the PLF (printed on the reverse of the form) will be available in different languages, which is likely to increase acceptability and compliance.

Practicalities and experience

Major logistical challenges in printing, distribution, collection, collation and analysis of HDCs were experienced during pandemic (H1N1) 2009. Although these will be less with PLFs, as they can be obtained more easily prior to vessels entering Australia, challenges will remain, particularly for analysis. There will also be logistical challenges in managing delays to passengers.

Timing

This measure should commence when notified of sustained human to human transmission of a novel virus. It must be used early to be effective, since its primary aim is to limit the entry of the disease into the community. The measure would cease when community transmission is well established.

B7: Thermal scanners

Application

Not recommended as effectiveness is likely to be low. Experience from SARS and pandemic (H1N1) 2009 shows that there may be a public expectation of entry screening in some form. Decisions not to do so should be supported by information to the public and decision makers.

Objective and Rationale

To detect infected incoming travellers so that on-going transmission can be prevented; to encourage self-reporting.

Effectiveness

Minor. If people are infectious when asymptomatic, the number of people entering without being detected will inevitably make the effectiveness of this measure low. Not all cases of influenza are febrile. Thermal scanners may be useful in identifying cases of diseases for which cases are not infectious until they are symptomatic, and one of the symptoms is a high temperature. The WHO *Global influenza preparedness plan* states that experience shows this measure is not effective.¹² The use of thermal scanners identified only 12% of all imported pandemic (H1N1) 2009 cases at arrival in Singapore. Data from Canada, China and Singapore showed that no cases of SARS were detected by thermal scanning among the more than 35 million international travellers scanned. The measure is not effective without further case management. Scanners seemed to provide some public reassurance during the 2009 pandemic, but this is likely to have been based on a false estimate of the effectiveness of the measure.

Risks and benefits

Risks: Use of thermal scanners may impede circulation of travellers within airports and seaports. This measure is indiscriminate, identifying anyone with a high temperature—including those who do not have a fever, or have a fever due to another cause—and thereby causing unnecessary delays and wasting resources. Large numbers of asymptomatic travellers will still bring the disease into Australia while the border measures have created a false sense of security.

Benefits: The measure encourages self-reporting (i.e. people think they will get picked up and be in trouble if they have not self-reported). As this measure is highly visible, it may inspire public confidence that something is being done to manage the outbreak

Direct costs

High. Costs include equipment purchase, calibration and storage; administration of contracts; training; and personnel. If medical resources are deployed at the border to support this measure, costs will include nursing personnel and personnel to bring ill travellers to nurses. There will also be costs associated with testing identified people. Thermal scanners require space in the airport or seaport.

Secondary costs

High, if supported at the border by medical resources. Medical resources deployed at the border will be associated with an opportunity cost, since they are likely to be a scarce resource and could be used elsewhere. There will be costs to individuals from delayed travel and lost productivity.

Likely acceptability and expectations

High for the public; low for implementing agencies. The public, upon whom there is small impost, is likely to be accepting of this measure; acceptability was high during pandemic (H1N1) 2009. Acceptability for implementing agencies will be low. Lack of confidence in the effectiveness of scanners and their high cost during pandemic (H1N1) 2009 led to a lack of support for their use among implementing border agencies.

Practicalities and experience

Thermal scanners are labour intensive. A lot of planning is involved in placing and managing them. They are difficult to use in peak times as people must go through in single file. This may lead to delays. Identification of possibly febrile individuals will require follow-up.

Timing

This measure should commence when notified of sustained human to human transmission of a novel virus. It must be used early to be effective, as its primary aim is to limit the entry of the disease into the community. It would cease when community transmission is well established.

B8: Border nurses

Application

Not recommended, as effectiveness is depends on the effectiveness of identification measures, which is likely to be low.

Objective and rationale

To support negative pratique, thermal scanners and/or HDCs/PLFs by following up ill travellers identified and so reduce on-going transmission, by providing case antiviral treatment and isolation and possibly contact tracing and quarantine of household contacts. Placement in airports/seaports reduces transport issues and time delays from moving people to be assessed and tested. An immediate nursing clinical assessment reduces the number of erroneous identifications, which are likely to be frequent due to lack of sensitivity in the initial case identification systems.

To detect (high risk) cases early to enable early treatment and prevent complications.

Effectiveness

The effectiveness of border nurses in reducing transmission is linked to the effectiveness of entry screening. As screening methods are not effective in detecting cases, border nurses will not have a significant impact on preventing transmission from imported cases. If disease is severe, at-risk groups are identified, or there is a high rate of disease in incoming travellers, early diagnosis and treatment associated with this measure could be of benefit.

Risks and benefits

Risks: Significant amounts of nursing time will be used for ill people who do not have influenza, since it is difficult to discriminate between influenza and other illnesses.

Benefits: Having easy access to health care may encourage self-reporting of infection by travellers. The measure will allow early testing, the opportunity for immediate antiviral treatment to reduce transmissibility and complications, the opportunity to advise self-isolation and self-quarantine of close contacts, and increased public confidence in control of infection.

Direct costs

High. Costs include nursing personnel (a scarce resource), taking ill travellers to nurses following identification (HR cost), space in the airport or seaport required for examination, pathology, consumables, drugs, PPE.

Secondary costs

High. There is an opportunity cost associated with this measure as nurses and border staff could be used elsewhere in the health system. Minor legislative change is required to authorise border nurses to conduct screening measures under the *Biosecurity Act 2015*.

Likely acceptability and expectations

Low. The opportunity cost will make this measure unpalatable to state and territory health systems that supply the nurses.

This measure is also more disruptive to travellers as it takes them out of the processing line.

Practicalities and experience

During pandemic (H1N1) 2009, difficulties related to security procedures were experienced in providing rapid access within airports for nurses. Suitable facilities for this measure are not normally available in an airport or seaport. Nurses are a scarce commodity that could well be used in community care, hospital care or public health. Mechanisms exist at all times to assess and manage acutely sick travellers who require immediate medical care at the border. This may include transportation to a nearby medical facility with the oversight and advice of biosecurity officials and the relevant CHBO.

Timing

This measure should commence when notified of sustained human to human transmission of a novel virus. It must be used early to be effective as its primary aim is to limit the entry of the disease into the community. It may be of use in reducing morbidity and mortality early on if the rate of infection in travellers is high and disease is severe. This measure will become less acceptable to state and territory health departments as nurse shortages become more extreme. It would cease when community transmission is well established.

B9: Screening of passengers on cruise ships prior to disembarkation, where there is evidence of cases of influenza on board

Application

Not recommended unless there is evidence of high clinical severity.

Objective and Rationale

To reduce entry of the disease into the community through closer management of the entry of travellers on higher risk vessels. Cruise ships provide good conditions for the rapid spread of respiratory viruses as they allow interactions between large groups of people in enclosed environments. They also disembark passengers in several ports for a few hours, increasing the risk of spreading the virus.

Effectiveness

Minor. Modelling studies show that travel restrictions do not prevent global spread, although they may reduce the number of incoming cases. Severe restrictions of up to 99% reduction in travel from affected countries may be required to achieve a delay of 2–3 weeks in introduction of the disease to uninfected countries.

Risks and benefits

Risks: This measure may cause loss of goodwill from tourists.

Benefits: This measure may slow introduction of the disease into the community in early stages of the pandemic.

Direct costs

High. Costs include the costs to vessels of delays (including additional pay for personnel and additional food requirements), resources to implement screening processes, testing, and managing and accommodating identified cases.

Secondary costs

Costs include difficulties for people getting home after delays, and damage to the international perception of Australian tourism. There is also an opportunity cost, since the resources required (e.g. nurses) could be used elsewhere.

Likely acceptability and expectations

Low, though compliance is likely to be good, especially for diseases with a moderate to high clinical severity. It imposes a significant impost on travellers. During pandemic (H1N1) 2009 in Australia, one index case was responsible for the spread of the pandemic virus strain, resulting in 83 cases on a cruise ship (an attack rate of 3%). After disembarkation, cases undertook voluntary isolation, and asymptomatic passengers were quarantined at home for seven days. In a follow-up survey of 45 randomly selected quarantined passengers, only 2 reported refusing quarantine.

The WHO International Health Regulations¹³ require that measures not unnecessarily interfere with international trade and travel.

Practicalities and experience

Some argue that controlling disease outbreaks in ships has a minimal impact as a border measure due to the huge number of travellers who enter Australia through air traffic. On the other hand, as cruise ships provide the opportunity for intense transmission of the virus, the risk posed by cruise ships in introducing cases into Australia cannot be ignored. As respiratory diseases are common in cruise ships, disease surveillance systems already exist. They are usually performed on board by designated crew. Public health measures performed in cruise ships include isolation of cases, training, advising, cleaning, respiratory etiquette and surface disinfection. Advice on the management of cases of pandemic (H1N1) 2009 on ships was issued in 2009 by the WHO and remains a useful reference. It is available at http://www.who.int/csr/resources/publications/swineflu/cp011_2009_1029_who_guidance_H1N1_ships.pdf.

Timing

This measure should commence when notified of sustained human to human transmission of a novel virus. It must be used early to be effective as its primary aim is to limit the entry of the disease into the community. The measure would cease when community transmission is well established.

B10: Voluntary isolation of ill travellers not requiring hospitalisation

Application

Ill travellers identified at the border through other measures, such as thermal scanners or HDCs could be encouraged to isolate themselves as part of a broader policy of voluntary isolation of those with influenza-like illness. It should be considered that there may come a time when resources required to initiate this at the border would be better used elsewhere. On its own, it is unlikely to have a high impact on reducing transmission due to limitations in identifying cases. Returning Australians may isolate themselves at home, however other arrangements would be required for other travellers.

Objective and Rationale

To reduce exposure to the disease by managing the entry of ill travellers at the border.

Effectiveness

Minor. In modelling studies, isolation of infectious cases is effective in reducing transmission by reducing cumulative attack rates, even in models assuming high transmissibility.^{14, 15} However, this assumes the ability to identify cases. Mild or asymptomatic cases are difficult to detect and therefore not usually isolated, reducing the effectiveness of this measure.

Risks and benefits

Risks: When people are isolated at home caregivers would be at high risk of infection due to more concentrated exposure and, families would be at risk of infection. Compliance may be low in mild or asymptomatic cases.

Benefits: This measure may delay spread of the disease within the community.

Direct costs

Moderate if isolated at home; high if isolated in hotels. Costs include accommodation, food, servicing, medical support, security, entertainment, and establishing and maintaining a support system to monitor people isolated.

Secondary costs

Moderate. Costs include loss of wages, lost productivity from time spent in isolation, paid time off work for caregivers, and impacts on small business.

Likely acceptability and expectations

During the SARS outbreak, compliance with self-isolation was high in most countries. Difficulty may be created for caregivers, and loss of income due to isolation may be unacceptable in some circumstances. This is a high visibility measure. Communication would be important to increasing acceptability.

Practicalities and experience

Isolation of cases with mild symptoms may be difficult to enforce. No quarantine premises are available, and use of hotels is problematic. Self-regulated isolation may not be complied with, and the support lines required would be resource intensive. Traditionally Australians are quite compliant (as shown by the SARS outbreak and pandemic [H1N1] 2009), and so isolation could result in some reduction in spread.

It is not expected that the practice of isolation at the border will achieve significant benefits over assessing and managing possible cases when they re-enter the community, given the limited effectiveness of case identification at the border. Therefore, provision of advice and referral for assessment after travellers leave the airport is considered adequate.

Isolation of non-Australians would require resolution of issues such as visa extension, entitlement to medical care, and missing return flights or voyages. Issues of compensation may arise. See also social distancing measure Voluntary isolation of cases.

Timing

This measure should commence when notified of sustained human to human transmission of a novel virus. It must be used early to be effective as its primary aim is to limit the entry of the disease into the community.

The measure would be replaced with advice on influenza-like illness given to the general community when community transmission is well established. See menu item 'Self-isolation of cases' for discussion of duration of isolation.

B11: Quarantine of contacts of ill travellers at the border

Application

Not recommended. The contact tracing required to identify and contact contacts of ill travellers is difficult to achieve in the necessary rapid timeframes, and requires significant resources. Combined with the limited effectiveness of case identification at the border, it is likely that the benefits will be limited. Returning Australians may quarantine themselves at home, however other arrangements would be required for other travellers.

Objective and Rationale

To prevent or reduce on-going transmission from infected travellers.

Effectiveness

Minor. Evidence suggests that, in combination with other measures, quarantine of contacts may have some effectiveness in reducing secondary infection. During pandemic (H1N1) 2009 in Japan, the use of antivirals and quarantine of contacts of imported PCR-positive cases may have prevented some further spread. Isolation and quarantine of ill people and contacts identified on the basis of screening is ineffective in preventing continuing transmission unless the proportion of infections occurring before symptom onset falls below a threshold value. A usable value can be applied for SARS and smallpox, but not for influenza. Delays in follow-up can dramatically reduce effectiveness.

Risks and benefits

Risks: There is a significant burden on health and other systems from this measure.

Benefits: Secondary transmission may be reduced if compliance is high enough and sufficient cases are identified. This measure may delay some spread of the disease within the community, however the proportion would be so low as cases increased within the general community, that this measure would have no noticeable effect on the course of the pandemic.

Direct costs

Moderate if isolated at home; high if isolated in hotels: Costs include accommodation (which will be a substantial cost), food, servicing, medical support, security and entertainment. Extensive infrastructure is required, including databases, information and surveillance hotlines, and staff to carry out contact tracing and monitoring, and to enforce quarantine.

Secondary costs

Moderate. Costs include loss of productivity and wages, impacts on small business and impacts on tourism. In the SARS experience in Toronto, some people lost their jobs because of the need to comply with quarantine for at least 10 days.

Likely acceptability and expectations

Low. High costs and significant impost on travellers and services would occur with this measure. It would also be highly complex to arrange and maintain. It is likely to draw significant criticism.

Practicalities and experience

Acceptability is likely to be low unless disease is very severe. Compliance may be low; ethical issues may arise from confining individuals; and stress may result from confinement. No quarantine premises are currently available, and use of hotels is problematic. Quarantining of non-Australians would require resolution of issues such as visa extension, entitlement to medical care, and missing return flights or voyages. Issues of compensation may arise. See also social distancing measure Quarantine of contacts.

Timing

This measure should commence when notified of sustained human to human transmission of a novel virus. It must be used early to be effective, since its primary aim is to limit the entry of the disease into the community.

The measure would cease when community transmission is well established. See menu item 'Voluntary quarantine of contacts' for discussion of duration of isolation.

B12: Exit screening

Application

Not recommended as effectiveness is likely to be low and costs are likely to be high. It could be considered if the virus emerges first in Australia.

Objective and Rationale

To reduce the number of ill travellers travelling from Australia to reduce the international spread of the disease.

Effectiveness

Minor. Modelling studies suggest that exit screening can be effective in delaying local epidemics by a few (1–3) weeks. However, this assumes a high degree of effectiveness in detecting and preventing travel by cases, which is unlikely to be the case in practice.

Risks and benefits

Risks: External pressure to apply exit screening from WHO and other countries may cause diplomatic tension. Lack of effectiveness of screening measures may lead to criticism if infected people are allowed through screening.

Benefits: Benefits would be experienced primarily by other countries. For example, there may be some benefit to small island countries where the community has to date had little exposure to the disease; however, low detection rates and the potential for asymptomatic travel mean that the influence of exit screening is still likely to be small.

Direct costs

High. Costs include staff to implement screening (a large number of staff would need to be used to avoid delaying passengers and vessels), advertising exit screening arrangements, support for screening (e.g. staff, materials such as passenger locator documents), medical resources if they are deployed at the border, and staff and health resources to investigate and manage individuals detected.

Secondary costs

High. Costs include delays to flights, and opportunity costs if medical resources are deployed at the border.

Likely acceptability and expectations

Low. This measure is not familiar to Australians and is therefore likely to be less acceptable than entry screening.

Practicalities and experience

Exit screening may be recommended by the WHO under the International Health Regulations, although this is not an obligation. As asymptomatic people may be infectious and will not be prevented from travelling, preventing symptomatic travellers from travelling is unlikely to be effective in preventing the spread across countries.

Exit screening arrangements would need to be widely advertised, so that travellers are aware before they arrive at airports or seaports. Law enforcement officers would also be likely to be required to manage restriction of passengers from boarding scheduled flights.

Timing

To influence transmission patterns, this measure would need to be implemented before widespread global evidence of the disease.

B13: Internal travel restrictions (restriction of travel across state or territory borders, or within certain areas of a state or territory, either to protect remote communities or to isolate areas with higher rates of exposure)

Application
Not recommended in general as benefits are likely to be minor.
Objective and Rationale
The delay or prevent the transmission of influenza from one town or region to another.
Effectiveness
<i>Minor.</i> Very limited evidence suggests that high travel restrictions (e.g. 50%) may bring about a minor benefit, and low travel restrictions (e.g. 10%) may be of no benefit.
Risks and benefits
<i>Risks:</i> Strict travel restrictions could seriously affect key societal functions, including the supply of food and fuel. <i>Benefits:</i> Very limited delay or prevention of transmission is possible.
Direct costs
High. Costs would include loss of income to transport authorities, travel-dependent industries and trade. Costs would be incurred from preparing and distributing promotional materials; potential screening activities on entry to airports, seaports, and bus and train stations; or closure of airports, which might require compensation. More localised restrictions would probably require enforcement by some kind of police or army presence.
Secondary costs
Secondary effects are likely to be high. Restrictions on travel may indirectly impair supply of essential commodities and disrupt economic activities.
Likely acceptability and expectations
Acceptability of air travel restrictions is likely to be high. Acceptability of land travel restrictions is unknown however it is expected to be lower.
Practicalities and experience
This measure is likely to be impractical in the Australian context. Non-essential travel is likely to decline in any case. Legal authority to implement this measure would need to be investigated. Some remote communities may choose to implement this measure. This would require organisational support to ensure availability of essential supplies.
Timing
To be effective, this measure should be enacted as soon as the first cases are detected in a region.

Menu of actions: social distancing measures

Social distancing is a community level intervention to reduce normal physical and social population mixing in order to slow the spread of a pandemic throughout society.

Social distancing measures may complement measures applied to individuals to decrease the likelihood of spread of pandemic influenza. Implementation of many social distancing measures would occur outside the health sector. The role of health sector experts and decision makers would be to develop and forward recommendations to central governance bodies, such as the National Crisis Committee, for consideration and action by relevant parties.

The summary tables which follow this introduction provide information on factors to consider in developing recommendations on:

- Proactive school closure;
- Reactive school closure;
- Workplace closure;
- Home working; and
- Cancellation of mass gatherings.

Related public health measures, with the similar aim to reduce transmission by reducing contact between infectious cases and uninfected individuals, include the isolation of cases and quarantine of contacts. The summary tables which follow this introduction provide information on the factors relevant to deciding whether to implement self-isolation of cases and voluntary quarantine of contacts, as well as another related measure: contact tracing.

This, the Menu of Actions: Infection Control section of the AHMPPI, is to be used in conjunction with the *Australian Guidelines on for the Prevention and Control of Infection in Healthcare (2010)* to provide support for the implementation of social distancing measures in healthcare settings. The management of cases and contacts at the Australian border have specific considerations and are discussed in the border measures section above.

Within the community, case and contact management will be conducted by state and territory health departments according to jurisdictional guidelines. Decisions concerning the identification and management of contacts (contact tracing) will consider the benefits of public health interventions (such as quarantine and antivirals) and the benefits of collection of surveillance data to inform decision making (discussed further in the Surveillance Plan). Evidence suggests that compliance with, and hence effectiveness of, home isolation and quarantine depends on multiple factors including the perception and understanding of risk associated with infection/illness, and financial considerations. Early and transparent communication to the public will be an important component of implementing home isolation and quarantine.

During the Initial Action stage, little may be known about the impact of the pandemic, and what information is available is likely to suggest moderate–high morbidity and mortality. Therefore, early on case and contact management is likely to reflect a precautionary approach (for moderate–high disease severity), and include both isolation and quarantine.

As surveillance information becomes available, the management of cases and contacts can be modified to suit the characteristics of the disease and to more effectively manage limited public health resources. For example, in a pandemic with high mortality and morbidity, preventing transmission as much as possible is important, and so both isolation and quarantine may be continued.

Compliance and benefits with social distancing measures are likely to be highest when disease is clinically severe. Where transmission is occurring quickly and severity is lower, the practicalities of implementing and supporting contact quarantine may outweigh the potential benefits. Isolation is likely to have the most impact on spread of virus when transmissibility is low and/or asymptomatic cases rare. As the pandemic progresses, decisions will become more pragmatic as the potential benefits of these measures are balanced against resourcing, capacity and social impact/disruption. The impact of these interventions is dependent on early application.

The recommended period of isolation for cases, and quarantine for contacts, will primarily be determined by the period of communicability and incubation period of the disease. The use of antivirals for treatment and/or prophylaxis may modify the length of these periods of isolation (shorten), depending on their efficacy in reducing transmission. At the time of the pandemic, the period of isolation and quarantine should be considered in the light of the specific information about the characteristics of the current disease.

During the Initial Action stage, the period of isolation and quarantine will be based on previous and current knowledge of pandemic influenza viruses (planning assumptions) and available evidence of the current pandemic disease. As more information becomes available from surveillance and specific studies, these may be modified during the Targeted Action stage.

Quality of evidence

Social distancing measures are considered to be an important part of 'defence in depth' against pandemic influenza although the available evidence is weak. Overall, social distancing measures are found to be modestly effective. Although the pandemic (H1N1) 2009 generated fresh evidence, the overall quality of the evidence was not strong as it derived predominantly from observational studies or mathematic modelling.

The evidence concerning the overall effectiveness of isolating cases is moderate. It is limited to a small number of modelling studies that tried to measure the impact of isolation of affected cases at home. Modelling of the isolation of household contacts of index cases suggest this may be beneficial.

SD1: Proactive school closure

Application

Not generally recommended, however could be considered when there is evidence of high clinical severity and/or high transmissibility specifically in children. The level of disruption is likely to outweigh benefits.

Objective and rationale

To limit community spread of the virus.

Rationales for using proactive school closure include the following:

- Respiratory infections have been observed to spread easily in day-care and school settings and are considered likely to show the same features during a pandemic.
- Children are at greater risk of transmission and infection, due to their developing immune systems and immature hygiene practices.
- Children are potentially a group at risk of complications (the 1957 pandemic showed a focus of transmission in children).

Effectiveness

Moderate. Modelling suggests reduced transmission by 1–50%. Studies suggest that school closure delays the epidemic peak by a week or two and flattens the wave of the epidemic.

Risks and benefits

Risks: This measure may cause workplace and economic disruption, as a large proportion (about 40%) of Australian parents, including healthcare workers, would need to take unplanned leave from work. Some children may be left without supervision. The benefits would be reduced if children continue to have contact with others during the school closure period. Children may find changes in their normal routine unsettling.

Benefits: This measure may moderately reduce and delay transmission.

Direct costs

Moderate. Costs include increasing security and communicating school closures.

Secondary costs

Extreme. Costs include workplace absenteeism of parents and carers who need to provide care and supervision to school children; disruption of school curricula; and possible delays to examinations, with implications for senior high-school students. There may be economic implications for parents without access to paid parental leave.¹⁶

Likely acceptability and expectations

School closures of limited duration would be largely acceptable in Australia if their purpose was understood, though this will depend on individual circumstances.

Practicalities and experience

Decisions about school closures may vary unless there is central direction.

The effects on transmission may be smaller than predicted by modelling studies, as children also mix outside schools.

The secondary effects of proactive closure are likely to be worse than those of reactive closure, because the reactive closures would be in response to specific cases, whereas proactive closures would be speculative and potentially prolonged, and may include many schools where no transmission is occurring.

To have a significant effect, school closure may be required throughout most of the pandemic (i.e. at least 8 weeks). The practicalities of closing schools for such a long period are problematic, particularly around exam times.

Timing

If longer term closure is considered, it is better to introduce this measure as soon as possible.¹⁷ This is because starting early in the epidemic will maintain a lower R_0 (transmission coefficient) and achieve lower eventual attack rates. However, this may be seen as unsustainable. If a short period of closure is implemented, it is preferable to close schools a few weeks before the epidemic's peak. While early closure is most likely to reduce initial epidemic transmission, there is a risk of 'rebound' epidemics on reopening schools. This would need to be managed proactively.

SD2: Reactive school closure

Application

Not recommended unless the disease has high clinical severity or children are a group at risk of complications.

Objective and rationale

To reduce increasing or uncontrolled influenza transmission in school settings where transmission is taking place. To respond to staff shortages.

Rationales for using reactive school closure include the following:

- Respiratory infections have been observed to spread easily in day-care and school settings and are considered likely to show the same features during a pandemic.
- Children are at greater risk of transmission and infection, due to their developing immune systems and immature hygiene practices.
- Children are potentially a group at risk of complications (the 1957 pandemic showed a focus of transmission in children).

Effectiveness

Variable but generally *moderate* overall. Reactive school closures have been reported to reduce transmission by 7–15%; on rare occasions, up to 93% reductions have been demonstrated in modelling.

Risks and benefits

Risks: This measure may cause workplace and economic disruption, since a large proportion (about 40%) of Australian parents would need to take unplanned leave from work. Some children may be left without supervision. Children may find changes in their normal routine unsettling.

Benefits: This measure may moderately reduce and delay transmission.

Direct costs

Moderate. Costs include increasing security and communicating school closures. Public health unit resources would be needed for tasks such as contacting notified cases of school age and liaising with schools. There may be economic implications for parents without access to paid parental leave.

Secondary costs

Extreme. Costs include workplace absenteeism of parents and carers who need to provide care and supervision to school children, and disruption of school curricula.¹⁶

Likely acceptability and expectations

School closures of limited duration would be largely acceptable in Australia if their purpose was understood, though this will depend on individual circumstances.

Practicalities and experience

The effects on transmission may be smaller than predicted by modelling studies, as children also mix outside schools.

Timing

The optimal timing of this measure is not known for certain. It should be considered when the attack rate of influenza-like illnesses reaches 5%.

SD3: Workplace closure

Application

Not generally recommended. Although some specific workplaces may be able to accommodate closure, it is unlikely that a large enough percentage could participate to significantly affect the pandemic's impact. This measure is only relevant if clinical severity is moderate to high.

Objective and rationale

To reduce transmission of influenza in workplace settings.

Proactive workplace closure is not considered here as a measure as determining triggers describing sufficient evidence of transmission to warrant closure, in a timeframe which would make closure effective, will be problematic. Reactive closure may be considered after introduction of the virus into workplaces especially if simultaneous to local school closure.

Effectiveness

Moderate. Modelling suggests that at least one-third of workplaces would need to be closed to bring an epidemic under control (to achieve an attack rate of less than 5%).

Risks and benefits

Risks: This measure may cause disruption to businesses, threats to income and job security, and economic strain on families if closures are prolonged. It is not plausible for essential services and supplies (e.g. medical goods).

Benefits: This measure may allow better control of transmission.

Direct costs

High. Costs would depend on the workplace. There would be substantial costs from closure for any period of time due to lack of production and engagement in business. Costs would also result from announcements, promotional materials and potentially requests for compensation. The cost of worker compensation, if provided, would be very high.

Secondary costs

High. Costs include effects on profits, availability of goods and services, and job security. Modelling has estimated the macroeconomic impacts of school and workplace closure are likely to exceed costs caused by the pandemic itself.¹⁸

Likely acceptability and expectations

Acceptability will depend on the business. Closure is likely to be acceptable to employees, particularly if they are sufficiently compensated, although data about this is not available in the Australian context. It would be important to have a clear understanding of benefits and entitlements between employees and employers.

Practicalities and experience

Modelling suggests that at least one third of workplaces would need to be closed to bring an epidemic under control. This would cause substantial disruption and economic impact. The measure may therefore be impractical. It may also be impossible to close some workplaces (e.g. aged and healthcare industries). Some workplaces may ultimately close as a result of staff illnesses. Some businesses, such as pharmacies, may need to expand to meet demand. There may be limitations to computer systems' capacity to support high numbers of people working from home.

Timing

Precise data from Australia concerning timing of this measure are not available. Workplace closures at the same time as school closures would avoid associated workplace disruption, but this alignment is unlikely in cities if workplace and school closures are reactive only.

SD4: Working from home

Application
This measure should be considered for pandemics with a moderate to high clinical severity, and where home working can be reasonably accommodated. Home working may not be practical for many workplaces.
Objective and rationale
To allow employees who may or may not be infectious to work from home and therefore decrease transmission outside domestic settings.
Effectiveness
<i>Minor.</i> This measure is moderately effective in reducing transmission of influenza by about one-fifth. A Japanese trial that assessed the effectiveness of home stay of employees on full payment found that the strategy reduced the overall risk of pandemic (H1N1) 2009 influenza by around 20%. ¹⁹
Risks and benefits
<i>Risks:</i> Productivity may potentially be lower, due to lower levels of supervision, access to resources or assistance. <i>Benefits:</i> This measure provides people who have been 'quarantined' with the capacity to continue to work from home.
Direct costs
Direct costs of home working (compared with travelling to work) have not been well studied. There may be minor costs of planning.
Secondary costs
Minor and variable. Home working may not be feasible for all, especially for self-employed people, who may suffer serious financial problems. Where home working is possible, there may still be reduced productivity and coordination.
Likely acceptability and expectations
The measure is likely to be acceptable among employees if they are paid fully (this would be an internal organisational issue), although precise data in the Australian context are not available.
Practicalities and experience
It may not be practical to do all types of work from home; many functions must be conducted in designated places. There will also be capacity limitations with IT systems which will severely limit the number of workers able to simultaneously remotely access their organisations' servers. Guidance must be given on the definition of an appropriate isolation period (see menu item 'Self-isolation of cases') for the conditions of isolation (e.g. contact limitations, use of PPE etc.).
Timing
No data on timing are available, but the measure should be considered once community transmission occurs.

SD5: Cancellation of mass gatherings

Application

Not generally recommended, however, may be considered if the disease has a high clinical severity rate and moderate to high transmissibility, at certain stages in the progress of the pandemic.

Objective and rationale

To reduce transmission of influenza by limiting the number of potentially ill contacts an individual is exposed to.

Effectiveness

There is some evidence to suggest that mass gatherings can amplify the risk of influenza transmission. One modelling study that examined the impact of mass gatherings specifically found large increases (around 10%) in the simulated peak prevalence as a result of the occurrence of mass gatherings within 10 days before the epidemic peak. However, mass gatherings that occurred much earlier or later in the epidemic would have relatively little effect—for example, if they were more than 40 days before or 20 days after the peak when the initial R_0 (transmission coefficient) is 1.5.

Risks and benefits

Risks: Certain mass gatherings may be important to maintain public morale.

Benefits: Benefits are uncertain.

Direct costs

Moderate. Costs will result from planning and arranging cancellations, especially in the absence of insurance. The issue of financial liability and meetings insurance would be crucial.

Secondary costs

High. Secondary costs will especially affect those who organise meetings and events, and derive an income from that work.

Likely acceptability and expectations

Acceptability is likely to be high, but members of the public may oppose banning certain types of gatherings (e.g. religious or sports gatherings).

Practicalities and experience

Cancellation of meetings and events is not without precedent, and contingency plans are generally in place. Communication materials will need to be employed to notify people of cancellations. These messages may not reach all parties.

Timing

To be effective, this measure should be enacted within 10 days before an anticipated peak of an epidemic.

SD6: Voluntary isolation of cases

Application

Voluntary self-isolation of cases is **recommended** (particularly as the clinical severity of the disease increases), to be used in conjunction with infection control measures to reduce the risk of transmission to household contacts. Most likely to influence the course of the pandemic when clinical severity is high and transmissibility is low.

Objective and rationale

To reduce transmission by reducing contact between infectious cases and uninfected persons.

Effectiveness

Minor. Modelling studies have demonstrated that the action of isolation may delay the peak of an influenza pandemic, especially when combined with other preventive measures.

Isolation is likely to have the most impact on the spread of the virus when transmissibility is low and/or asymptomatic cases are rare. Impact is dependent on early application.

Risks and benefits

Risks: Household contacts of the index case are at risk of acquiring the infection.

Benefits: Benefits will be minor (see 'Effectiveness'). They are most likely if clinical severity of disease is high and transmissibility is low.

Direct costs

Expected to be minor. Costs will result from loss of income and may disproportionately affect lower income groups.

Secondary costs

Minor. Contacts may be at risk of acquiring infection, and both cases and contacts may suffer from psychosocial distress. There would be disruption to workplaces and the economy in a large-scale pandemic.

Likely acceptability and expectations

Acceptability and expectations are variable but overall high (>80%) in Australia. Experience is that compliance is higher in households that are well informed about quarantine than in those that are less well informed.

Practicalities and experience

Consideration may need to be given to support mechanisms, such as financial, psychological, social, physical and other needs of the patient and caregivers while they are in isolation.

During pandemic (H1N1) 2009 influenza in Australia, it was found that, from a public health response perspective, a number of factors were integral to ensuring effective isolation and quarantine: a flexible incident control system, a web-based multi-user access database with both reporting and case management capacity, upskilling of surge staff, and electronic communication.

Timing

The isolation period will be based on available evidence of the pandemic disease during the Initial Action stage and modified for the Targeted Action stage when adequate information is available from surveillance. Voluntary self-isolation of confirmed cases should begin early and remain throughout the pandemic period. Voluntary self-isolation based on symptoms should begin once transmission starts to become widespread

SD7: Voluntary quarantine of contacts

Application

Recommended in the Initial Action stage, and **consider** in the Targeted Action stage, particularly if consequences of infection are high.

Objective and rationale

The aim of quarantine is to reduce transmission of influenza by preventing its spread through seclusion of contacts of cases. Contacts could be asked to isolate themselves for a period after their last exposure to the case. If symptoms occurred, they would continue to isolate themselves and seek medical advice.

Effectiveness

Moderate. The quality of available evidence is low; however, it suggests that quarantine of contacts may reduce the peak case load and delay the peak of a pandemic. A modelling study of the Asian influenza pandemic 1957–58 showed that rates of illness and mortality were reduced by around 50% if people with influenza-like illness and their household contacts stayed home; compliance was assumed to be 40%. A study in Japan found that the overall risk of pandemic (H1N1) 2009 influenza was reduced by about 20% by ill employees staying at home on full pay. The impact of this measure will depend on early application and rapid identification of cases.

Risks and benefits

Risks: Quarantining of contacts sharing the same room or toilet with index cases significantly increases the risk of acquiring the infection among the contacts. There is a significant burden on health and other systems from this measure.

Those affected by quarantine may report distress due to fear and risk perceptions.

Benefits: Benefits will be moderate (see 'Effectiveness'). Compliance and benefits will be highest when disease is clinically severe. Provision of antivirals to contacts would be likely to reduce morbidity and mortality in this group.

Direct costs

Potentially high, depending on the number of cases. Costs will result from a substantial number of people being absent from work.

Secondary costs

Moderate. Costs will result from the increased risk of secondary transmission among isolated contacts and the consequent disruption to work and society.

Likely acceptability and expectations

Acceptability of quarantine measures is likely to be high in Australia, especially if the public is well informed about the consequences of a pandemic, though this will depend on individual circumstances.

Practicalities and experience

It is important to consider that contacts remain highly susceptible to acquiring the infection from index cases if they are quarantined in the same house. They should therefore be separated from the index case, whenever possible; this may not always be practical. Consideration may need to be given to support mechanisms such as financial, psychological, social, physical, and other needs of the patient and caregivers while they are in isolation.

Timing

The period of quarantine will be based on available evidence of the pandemic disease during the Initial Action stage and modified for the Targeted Action stage when adequate information is available from surveillance. No data on the timing of introduction of quarantine are available, but quarantine should be considered during the Initial Action for contacts of confirmed cases. Consideration should be given to basing quarantine on symptoms once transmission becomes more widespread.

SD8: Contact tracing

Application

Important part of initial enhanced surveillance activities. If it is aimed at reducing morbidity and mortality, consider if clinical severity is high.

Objective and rationale

To reduce transmission by identifying people who have been in close contact with symptomatic cases and implementing interventions such as voluntary isolation or antivirals. To reduce morbidity or mortality by promoting prompt treatment.

To obtain surveillance data to support modelling of pandemic impact levels.

Effectiveness

Minor. Effectiveness depends on the capacity to identify cases and locate their close contacts, and the effectiveness of the interventions applied (see menu items relating to isolation and antivirals). Since the low sensitivity of case definition and detection methods mean that the capacity to identify cases is low, evidence suggests that the ability of contact tracing to significantly influence pandemic transmission rates is also low. Interventions are less effective after 48 hours, and it is difficult to trace contacts within that time; these factors also limit the likely effectiveness of this measure. However, prompt treatment of people at higher risk is likely to influence morbidity and mortality. The extent of the treatment program will dictate the level of impact.

Risks and benefits

Risks: This measure imposes a significant burden on health and other systems.

Benefits: The measure would be valuable as part of early information gathering to assist understanding of the disease. Early in the pandemic, when the clinical severity of the disease is unknown, contact tracing may be prudent to reduce morbidity and mortality of people known to have been exposed to infection before widespread community transmission. Similarly, if clinical severity is known to be high, contact tracing before widespread transmission may be worthwhile to help reduce morbidity and mortality. Only minor overall reduction in transmission is likely.

Direct costs

Moderate to high. Contact tracing requires a high level of human resources.

Secondary costs

High. Costs of associated interventions may be high, depending on the protocol adopted to determine how extensive contact tracing should be and the interventions implemented. There is an opportunity cost associated with use of health resources, which could be better used elsewhere, depending on the stage of the pandemic and the clinical severity of the disease.

Likely acceptability and expectations

Contact tracing is regularly undertaken for other diseases by public health units, but not routinely used for seasonal influenza. The perception of the benefit of contact tracing for influenza to reduce transmission is likely to be low, but will be higher where the purpose is to reduce morbidity and mortality of a disease with a high clinical severity. Acceptability is likely to be good if seen as part of initial enhanced surveillance activities.

Practicalities and experience

Contact tracing of travellers is difficult to achieve in the necessary rapid timeframes. The process of locating and informing contacts is also laborious. To identify contacts from aircraft, information must be obtained from airlines (unless PLDs are in use). This may require reference to head offices and therefore takes time. For ships contact tracing is also problematic as passengers circulate widely on board, potentially creating the need to contact many passengers. This measure is more feasible early in the pandemic when numbers of cases are lower.

Timing

This measure should commence when notified of sustained human to human transmission of a novel virus. If used for surveillance data gathering, it would cease when the characteristics of the disease are understood. If used to reduce transmission, morbidity or mortality, it would cease when community transmission is well established.

Menu of actions: pharmaceutical measures

The pharmaceuticals referred to in this Menu include antivirals, candidate pandemic vaccines (a vaccine based on a strain of influenza virus considered to have pandemic potential), customised pandemic vaccines (a vaccine based on the actual pandemic virus) and seasonal influenza vaccine. References to antivirals relate to the neuraminidase inhibitors (NAIs) oseltamivir and zanamivir. The recommendations made in this Menu assume the pandemic virus is susceptible to these NAIs. The evidence used in this menu will be periodically reviewed to incorporate new antiviral agents.

This Menu examines:

- Antivirals for treatment of cases
- Antivirals for post exposure prophylaxis for contacts
- Antivirals for post exposure prophylaxis for at-risk groups
- Antivirals for pre exposure prophylaxis for healthcare workers
- Candidate pandemic vaccine
- Customised pandemic vaccine
- Seasonal influenza vaccine

Antivirals

Antiviral medications can be used for treatment of infected cases, prophylaxis of exposed contacts, and pre-exposure prophylaxis for healthcare workers at high risk of infection. Treatment with antivirals aims to reduce symptoms in individuals and hence lower morbidity and mortality. Prophylactic use of antivirals aims to reduce the risk of infection and illness in contacts, potentially lowering the spread and hence disease attack rate. A reduction in mortality and morbidity, and transmission, will assist in minimising impact on health care services during a pandemic. The most commonly used antivirals in the community are oseltamivir and zanamivir.

The appropriate strategy for the use of antivirals will depend on the stage of the pandemic, the epidemiology (transmissibility and clinical severity) and virological (antiviral resistance) characteristics of the virus, pre-existing immunity, vaccine availability and practicalities such as logistics of antiviral delivery and availability.

During the Initial Action stage, it is possible that little will be known about the clinical severity of the disease and the likely impact of the pandemic, however the available information is likely to suggest moderate to high morbidity and mortality. As surveillance information becomes available, the antiviral strategy can be modified to more effectively manage the specific pandemic. For example, in a pandemic with high mortality and morbidity, preventing illness in as many individuals as possible is important to minimise mortality and morbidity, reduce transmission to others and maintain the health workforce. When severity is lower, protecting those at risk of severe outcomes becomes the focus.

Rapid distribution is key to the effectiveness of antivirals at a population health level. All stakeholders, including jurisdictions, will need to have considered appropriate distribution strategies. Alternate strategies for distribution of antivirals and administration of vaccines may be considered, such as a review of scheduling of antivirals to improve ease of access, and use of pharmacies to provide vaccinations.

Quality of evidence

There is consistent good quality evidence regarding the effectiveness of antivirals to treat cases. However, the evidence concerning the impact of antivirals on severe outcomes is not as high in quality. Evidence of the effect of antivirals to limit transmission, either from treated cases or through provision of prophylaxis to close contacts is more limited and generally restricted to household studies. Use of mathematical models is a good method of exploring scenarios to consider the implications of transmission reducing approaches at whole population level, however their results simplify complex systems. The findings are dependent on and sensitive to the input information (e.g. transmission characteristics, population susceptibility, and individual behaviour) which are inferred rather than quantified by direct observation.

Remarkably few recent detailed studies exist on the cost effectiveness of antivirals for treatment and/or prophylaxis. Of the recent studies, there is no consistency in the approach taken, the underlying assumptions used, or the cost effectiveness measure used. Interpretation of the results of cost-effectiveness studies is problematic because of the wide range of transmissibility and severity under investigation and the high degree of variability in the approach and assumptions used.

Vaccines

Vaccination is the key tool to limit the number of individuals infected, as it allows individuals to be immunised without experiencing disease. Vaccine-related strategies for candidate vaccines, which are developed prior to a pandemic, are different from those developed for customised pandemic vaccines. Seasonal influenza vaccine has been included here to consider its capacity to provide protection against related influenza variants and as the familiarity of the public with seasonal influenza vaccines will influence attitudes, behaviours and existing health system arrangements.

Candidate pandemic vaccines

Avian-origin H5, H7 and H9 viruses, and swine-origin H3N2 variant viruses are all currently considered strains of pandemic potential, against which vaccine seed strains have been developed.²⁰

The effectiveness of candidate pandemic vaccines will depend on the similarity between the strain used to develop the vaccine and the strain causing the pandemic. Candidate pandemic vaccination strategies will depend on the timing and extent of infection in Australia, the availability of the vaccine, the knowledge of the efficacy and safety of the vaccine, and the predicted impact of the pandemic on Australia.

It may be necessary to prioritise vaccination of individuals at greater risk, such as healthcare workers, or individuals at high risk of severe outcomes. If sufficient time and stocks of vaccine are available to vaccinate the wider population, distribution strategies might aim to target individuals who are more likely to spread infection. Many details of the vaccination program would need to be determined, including the size of dose, the number of doses per person, and the delivery strategy, including which individuals or groups should be given priority. Communication of reasons for prioritisation would be important to prevent dissatisfaction within the community.

Administration of a candidate pandemic vaccine prior to established within-country transmission of an emergent strain would be recommended on specific advice from the WHO.

Customised pandemic vaccine

Once a novel strain of influenza has emerged, the WHO will recommend a suitable vaccine virus and the Australian Influenza Vaccine Committee will advise whether this is endorsed for use in Australia. Vaccine companies will then work to develop a new vaccine for that strain. The Australian Government has arrangements in place to ensure once a customised pandemic vaccine is developed that it could be purchased as quickly as possible. This development process may take several months, so the customised pandemic vaccine may not be available until the disease is widespread. As with the candidate pandemic vaccine, delivery

strategies will need to be devised to make best use of the customised vaccine as it becomes available. Unlike candidate pandemic vaccine strategies, however, the delivery strategy may need to take account of existing levels of immunity. For example, if high levels of immunity have already been achieved in children by natural infection, prioritising children for vaccination will have less impact on reducing disease spread and may not be a good use of resources. As with the candidate pandemic vaccine, individual compliance with vaccination is likely to depend on the perceived severity of the pandemic strain and the adverse effects associated with vaccination.

The public's perceived risk-benefit profile for vaccination is likely to be dynamic, becoming less favourable over the course of a pandemic response. For this reason, clear communication throughout the pandemic response is critical to ensure good uptake of the customised vaccine.

P1: Antivirals for treatment of cases

Application

Recommended for all cases during the Initial Action stage, within available resources and using a syndromic diagnostic strategy. In the Targeted Action stage, treatment strategies can be modified to more effectively manage the specific pandemic and maximise the clinical benefits of the resources available. Modified antiviral treatment strategies are listed below from most liberal to most constrained:

1. Treatment of all identified cases regardless of risk stratum or setting of care. Provision of post exposure prophylaxis for individuals in the population that are considered to be high-risk. (This option is likely to be considered in a limited number of pandemic scenarios).
2. Treatment of all identified cases regardless of risk stratum or setting of care. Prophylaxis is not recommended.
3. Treatment of all identified cases in the population that are considered to be high-risk. Treatment of all cases in hospital and ICU settings. Prophylaxis is not recommended.
4. Treatment of hospital and ICU patients only.

Objective and rationale

To manage and reduce the duration and severity of symptoms of influenza in individuals, hence reducing transmission, morbidity and mortality. This will in turn minimise the impact on health care services.

Effectiveness

Minor. Modelling studies suggest that treatment of cases only will have minimal (<2%) influence on the scale and progress of the pandemic. However, the effectiveness for individuals may be high. There is consistent good evidence for reduced duration of symptoms. For impact on severe outcomes, observational data (including data from pandemic [H1N1] 2009) and some meta-analyses) show reduced complications, hospitalisations and death. Some reduction in infectiousness will also result—for example, household study estimates include a reduction in secondary attack rate from 10.6% to 4.5%, and 16.6% to 2.1%.

In mild influenza infection, NAIs administered within 48 hours of onset of illness reduce the duration of illness by half to one day in at-risk populations (adults and children). This allows resumption of usual activities somewhat earlier than in the absence of treatment. Greater reductions may occur if the NAIs are taken earlier. Studies on pregnant women confirm the benefits of early administration, with reduced risks of hospitalisation, admission to intensive care and mortality.

Risks and benefits

Risks: Potential side-effects include nausea, vomiting and abdominal pain. There is a risk of resistance developing, which needs to be monitored. Resistance was identified in 2009 but was uncommon. Consideration should be given to whether there are limitations relating to women who are pregnant or breastfeeding.

Benefits: Treatment may reduce symptoms and thus reduce morbidity and mortality, and decrease disease transmission to contacts. It may also contribute to the prevention of secondary bacterial infection.

Direct costs

Moderate to high. Costs will depend on transmissibility and severity of the disease, and scope of treatment. Significant purchase, storage, maintenance and delivery costs will be incurred if antivirals are stockpiled. There will be additional costs for the administration of treatment to individuals.

Secondary costs

Secondary costs will include monitoring of adverse events. The costs will depend on factors such as disease transmissibility and clinical severity.

Likely acceptability and expectations

Compliance is likely to increase with disease clinical severity.

Practicalities and experience

Antivirals are only effective while being taken and are a prescription-only medication. Individuals will need to present to a healthcare provider for laboratory-confirmed or symptomatic diagnosis. They are available from the private market at cost to the individual when prescribed by healthcare providers. Since antivirals are not widely used in hospital or community settings, it would be necessary to stockpile them to ensure that they are available during a pandemic. Logistical difficulties exist in identifying cases and supplying the medication early enough to have an effect. It should be noted that no antiviral medicine is currently registered for use in children under 1 year of age.

Timing

Antivirals are more effective for individuals if they are used early, ideally within 48 hours of symptom onset. However, some studies indicate that antivirals may still have significant positive outcomes even if commenced more than 48 hours after symptom onset; mortality is reduced even if treatment is started as late as 6–8 days after symptom onset.

P2: Antivirals for post-exposure prophylaxis (PEP) of contacts⁴

Application

Recommended during the Initial Action stage within available resources. In scenarios with low clinical severity, to reduce mortality/morbidity, best directed towards those at greatest risk of severe illness. There is less benefit in reducing transmission to the general population. In scenarios of high severity, PEP for close and at-risk contacts is important to reduce mortality/morbidity and to reduce transmission, and hence risk of illness.

Objective and rationale

To reduce infection and spread, therefore reducing the number of secondary cases.

Effectiveness

Direct trials data estimates a 70–90% protective efficacy.

Modelling suggests that a strategy in which antivirals are used to treat cases and treat contacts may influence the epidemic curve. Controllability is most likely to be achieved where the disease has a high clinical severity (high visibility) and low to moderate transmissibility. The real-world logistical issues of stockpiling and delivery are likely to considerably reduce this impact. In addition, timely administration, supported by molecular diagnosis in the early epidemic phase, and on a syndromic basis during an established epidemic, has been demonstrated in modelling studies to be essential in the success of antiviral prophylaxis programs.

Risks and benefits

Risks: There is a risk of resistance developing if antivirals are overprescribed. This needs to be monitored. Resistance was identified in 2009 but was uncommon. The number of people who could be classed as contacts could be extensive, leading to depletion of stockpiles of antivirals. This should be considered when deciding which contacts will receive prophylaxis. Consideration should be given to whether there are limitations relating to women who are pregnant or breastfeeding.

Benefits: This measure may reduce infection and symptoms, thereby reducing morbidity and mortality, and disease transmission to contacts. It may also contribute to the prevention of secondary bacterial infection. The greatest benefits are anticipated where distribution is prioritised to at-risk individuals, resulting in the greatest achievable reductions in hospitalisations and deaths.

Direct costs

Moderate to high. Costs will depend on transmissibility and clinical severity of the disease, and scope of treatment. Significant purchase, storage, maintenance and delivery costs will be incurred if antivirals are stockpiled. There will be additional costs for the administration of treatment to individuals.

Secondary costs

Moderate to high. This measure requires contact tracing to identify individuals requiring prophylaxis.

Likely acceptability and expectations

Compliance is likely to increase with disease clinical severity. During pandemic (H1N1) 2009, there was some evidence of reduced compliance with antiviral prophylaxis due to adverse events, particularly in the United Kingdom. A study of Australian healthcare workers found that only 17.6% would work unconditionally during an influenza pandemic, with the majority saying that they would work if antivirals were available for prophylaxis or treatment.

Practicalities and experience

Feasibility of widespread prophylaxis decreases as transmission increases. Once widespread community transmission is established, provision of prophylaxis to extended contacts is not feasible and not an efficient use of resources. Only a limited number of doses will be stockpiled (limited by finance and storage capacity).

Defining which priority groups and healthcare workers are eligible for antivirals will be challenging; equity issues and differing levels of clinical severity will need to be taken into account.

Logistical difficulties exist in identifying cases and supplying the medication early enough to have an effect. Effective use of infection control measures, including PPE, by healthcare workers may help to reduce the requirement for antivirals. Antivirals are available from the private market at cost to the individual when prescribed by healthcare providers. It should be noted that no anti-viral medicine is currently registered for use in children under 1 year of age.

Timing

Antivirals are more effective in minimising symptoms if used early, ideally within 48 hours of exposure.

⁴ Exposure is defined as exposure to an infectious case within 1 metre for >15 minutes without a mask, as described in Influenza infection: CDNA national guidelines for public health units (July 2011) — www.health.gov.au/internet/main/publishing.nsf/Content/cdna-song-influenza.htm.

P3: Antivirals for post-exposure prophylaxis for at-risk groups

Application

Recommended during the Initial Action stage, within available resources. In scenarios of lower severity, to reduce mortality/morbidity, PEP is best directed towards those at greatest risk of severe illness. In scenarios of high severity, PEP for at-risk contacts is important to reduce illness in this group, and therefore reduce morbidity and mortality.

Objective and rationale

To reduce infection within at-risk groups where the potential for severe outcomes is higher.

Effectiveness

Modelling considered a scenario in which 10% of the population was 'at risk' due to at least one factor, and prioritised antiviral distribution to this group, within capacity constraints. Based on the reported global experience from pandemic (H1N1) 2009, it was assumed that these individuals had a five-fold higher risk of hospitalisation when infected, that each hospitalised individual had a 12.5% chance of admission to the intensive care unit (ICU) and, of those admitted to ICU, 40% died.²¹ The clinical attack rate in the 'at-risk' category mirrored that for the general population for low-impact scenarios, but was noticeably higher for medium- and high-impact epidemics, even with a highly effective intervention strategy (e.g. treatment and prophylaxis).

Even in high-transmissibility scenarios where the total clinical attack rate in either or both of the 'at-risk' and general population groups appeared unchanged by the intervention, the assumed efficacy of the drugs against severe outcomes, based on data from pandemic (H1N1) 2009, was seen in the halving of the number of deaths reported.

Risks and benefits

Risks: Potential side effects include nausea, vomiting and abdominal pain. There is a risk of resistance developing if antivirals are overprescribed. This needs to be monitored. Resistance was identified in 2009 but was uncommon. The number of people who could be classed as 'at-risk' could be extensive, leading to depletion of stockpiles of antivirals. Consideration should be given to whether there are limitations relating to women who are pregnant or breastfeeding.

Benefits: As the likelihood of severe disease increases, so do the benefits of the reduced risk. Treatment may reduce symptoms and disease transmission to contacts, thus reducing morbidity and mortality. It may also contribute to the prevention of secondary bacterial infection.

Direct costs

Moderate to high. The cost of prophylaxis for at-risk individuals depends on the number of individuals provided with prophylaxis. Significant purchase, storage, maintenance and delivery costs will be incurred if antivirals are stockpiled. There will be additional costs for the administration of treatment to individuals.

Secondary costs

Moderate to high. This measure requires efforts to identify at-risk individuals requiring prophylaxis.

Likely acceptability and expectations

Compliance is likely to increase with disease clinical severity. During the pandemic (H1N1) 2009, there was some evidence of reduced compliance with antiviral prophylaxis due to adverse events, particularly in the United Kingdom.

Practicalities and experience

Once widespread community transmission is established, targeted use of prophylaxis to reduce morbidity and mortality among particular groups is a better use of resources. Large quantities of antivirals would be required for prophylaxis for high-risk individuals. There will be logistical difficulties in identifying people in at-risk groups and supplying the medication early enough to have an effect. It should be noted that no anti-viral medicine is currently registered for use in children under 1 year of age.

Timing

Antivirals are more effective if used early, ideally within 48 hours of exposure.

P4: Antivirals for pre-exposure prophylaxis (PrEP) for healthcare workers

Application

Not routinely recommended during the Initial Action stage. The main benefit of PrEP is to maintain the health workforce; however, in low impact pandemics, other types of protection are likely to be adequate. Higher severity pandemics may have significant negative impacts on the healthcare workforce. PrEP may reduce this impact and assist in maintaining an adequate healthcare workforce.

Objective and rationale

To reduce infection and potentially lower transmission, to maintain the health workforce.

Effectiveness

Modelling studies have shown that prophylaxis coverage of healthcare workers has little impact on the transmission dynamics of the disease. However, healthcare workers play a critical role during a pandemic in maintaining a stable healthcare system. Provision of prophylactic antivirals to this group, as part of a package of protective measures, is considered to be one means of maintaining workforce capacity. Further study is necessary to determine the practicality of delivering antivirals to this group during a pandemic.

Risks and benefits

Risks: Potential side effects include nausea, vomiting and abdominal pain. There is a risk of resistance developing if antivirals are overprescribed. Resistance was identified in 2009 but was uncommon. A shortfall in the supply of antivirals is a risk if extensive PrEP is continued once transmission is widespread. Consideration should be given to whether there are limitations relating to women who are pregnant or breastfeeding.

Benefits: This measure may reduce symptoms and disease transmission, thus reducing morbidity and mortality. It may also contribute to the prevention of secondary bacterial infection. Reduced morbidity and mortality among healthcare workers will increase the availability of healthcare workers. Continuous provision of PrEP to healthcare workers is associated with a marked reduction in cases within this sector, because workers are protected against both occupational and community acquisition of infection, and is an efficient means to ensure ongoing service delivery.

Direct costs

Moderate to high. The cost of continuous PrEP for healthcare workers depends crucially on the proportion of workers given prophylaxis. Costs are likely to increase with transmissibility of the virus and thus the proportion of healthcare workers exposed. Significant purchase, storage, maintenance and delivery costs will be incurred if antivirals are stockpiled. There will be additional costs for the administration of treatment to individuals.

Secondary costs

Moderate to high. This measure requires the ability to identify healthcare workers requiring prophylaxis. There are also costs associated with workers taking compulsory drug-free periods and potentially being unable to work during that time.

Likely acceptability and expectations

Compliance is likely to increase with disease severity, but may wane over many weeks of antiviral use. A study of Australian healthcare workers found that only 17.6% would work unconditionally during an influenza pandemic, with the majority saying that they would work if antivirals were available for prophylaxis or treatment.

Practicalities and experience

Once widespread community transmission is established, targeted use of prophylaxis to reduce morbidity and mortality among particular groups, such as healthcare workers, is a better use of resources. Depending on demand, there may be a need to prioritise available stocks of antivirals. Prioritisation should be based on exposure to risk and duration of risk. Antivirals are only registered for six weeks of continuous use before a break is required. This would need to be factored into a strategy to provide healthcare workers with PrEP.

Timing

Use should be related to exposure to risk.

P5: Candidate pandemic vaccine

Application

For pandemics with a moderate to high severity use of candidate pandemic vaccine may be warranted for priority groups, such as of front-line responders (those who may be presented with initial cases), groups at risk of complications (advice on at-risk groups will be provided early in the pandemic) or key transmitting groups.

Objective and rationale

To protect individuals in order to maintain front line services and lessen the impact of the pandemic. Candidate vaccines may help to reduce the severity of illness in those that become infected, or prevent infection in some.

Evidence of effectiveness

Moderate. Current evidence shows generally moderate immunogenicity and generally acceptable safety profiles for most available candidate vaccines against influenza virus strains identified by WHO as having pandemic potential. Candidate vaccines are unlikely to offer the same level of protection as customised pandemic vaccine. Administration of such a candidate vaccine would be most effective early in a pandemic.²²

Risks and benefits

Risks: Possible adverse events, which occur at higher rates with adjuvanted vaccines, include swelling and redness at the injection site; low-grade fever, malaise and myalgia; and febrile convulsions in children. In a low-impact scenario, administration of candidate pandemic vaccines is likely to be associated with an adverse risk–benefit profile that would not justify the additional cost or workload. Receipt of seasonal influenza vaccine can block the acquisition of natural immunity resulting from influenza infection, potentially making recent seasonal vaccine recipients (particularly relatively immunologically naïve children) more vulnerable to pandemic virus strains. There may be limited or no experience with new vaccine formulations, particularly regarding the safety profile in relation to rare but serious adverse events such as narcolepsy and Guillain-Barré syndrome, as this requires long term use of vaccines in large population groups.

Benefits: Candidate vaccines can be stockpiled, which would allow pre-emptive administration in an anticipated pandemic scenario of high impact to induce immunity in priority groups. The benefits and cost-effectiveness would depend on vaccine effectiveness and rapid achievement of high coverage in the relevant priority groups. Use of a stockpiled vaccine for mitigation among high disease-risk groups could be appropriate in moderate- to high-impact pandemic scenarios, or in cases where high cross-protective efficacy was anticipated.²²

Direct costs

Costs will depend on quantity stockpiled, but include purchasing, storing and distributing vaccines/vaccination equipment; and coordinating the vaccination program, including developing clinical advice, developing and disseminating communications materials, briefing ministers and responding to media queries.

Secondary costs

Costs will depend on quantity stockpiled. This measure entails additional work for state and territory immunisation program managers and providers. Costs include monitoring and management of vaccine adverse events, and monitoring uptake and effectiveness of the vaccine.

Likely acceptability and expectations

Acceptability will depend on public perception of the impact of the pandemic and candidate vaccine safety. Public perceptions are likely to be dynamic. Clear communication will be critical and expectations around vaccine availability will need to be carefully managed.

Practicalities and experience

Difficulties associated with stockpiling include the need to maintain the stockpile with high likelihood of wastage due to the relatively short shelf life, and difficulties predicting which virus will cause the next pandemic.

Contracts managed by the Australian Government provide for purchase of candidate vaccine for the National Medical Stockpile. Factors influencing the decision to use a candidate vaccine will include vaccine availability (quantity in stockpile and/or potential to obtain further stocks), the anticipated impact of the pandemic, likely effectiveness against the pandemic strain, observed epidemiology of the virus and timeframe for customised pandemic vaccine production. Depending on these factors, strategic use might focus on maintaining the healthcare system, mitigating severe outcomes among the vulnerable, and/or reducing transmission in the population.

Timing

Consider pre-emptive distribution of candidate vaccine when notified of a novel virus of concern. Consider administration of vaccine when there is sustained human to human transmission outside of Australia, on the basis of expert advice from the WHO and ATAGI. Cease when supplies are exhausted, customised pandemic vaccines is available, or earlier on the basis of expert advice from ATAGI.

P6: Customised pandemic vaccine

Application

Recommended. A customised pandemic vaccine would protect against both infection and development of severe illness. The timeframe required to develop a customised vaccine is an important factor.

Objective and rationale

To protect individuals and reduce the impact of the pandemic and hence lower morbidity and mortality.

Evidence of effectiveness

Moderate. It is likely that a customised vaccine would provide a moderate (but greater than for a candidate vaccine) level of protection against both infection and development of severe illness, based on past experience with pandemic and seasonal influenza vaccines. The exact level of protection provided by a customised vaccine, particularly its effectiveness in different population groups, will not be known until the pandemic has begun and vaccine studies are performed. An acceptable level of immunogenicity will be required before the vaccine can be registered for use.²³ There also may not be sufficient time to assess effectiveness of vaccination with candidate vaccine before a customised vaccine is rolled out.

Risks and benefits

Risks: Possible adverse events, which occur at higher rates with adjuvanted vaccines, include swelling and redness at the injection site; low-grade fever, malaise and myalgia; and febrile convulsions in children. Adverse events may vary depending on the particular vaccine. Rare but severe adverse events can only be identified after use of such vaccines in much larger population groups than in small initial clinical trials. There may be a long wait for vaccine to become available, leading to higher numbers of cases.

Benefits: Customised vaccines are likely to be considerably more effective at protecting against pandemic influenza than candidate vaccines.

Direct costs

Moderate to high. Costs include purchasing vaccines, storing vaccination equipment, distributing vaccines and equipment; and coordinating a vaccination program, including developing clinical advice, developing and disseminating communications materials, briefing ministers and responding to media queries.

Secondary costs

Moderate to high. This measure entails additional work for state and territory immunisation program managers and providers, highlighting the need for an agreed immunisation strategy prior to a pandemic. Costs include monitoring/management of adverse events, and monitoring vaccine uptake and effectiveness.

Likely acceptability and expectations

Acceptability is likely to be moderate to high, depending on public perception of the severity of the pandemic and vaccine safety. Public perceptions are likely to be dynamic. Clear communication will be critical and expectations around vaccine availability will need to be carefully managed. Different strategies may need to be applied if there are multiple waves of the pandemic.

Practicalities and experience

Practical difficulties exist around the distribution and administration of vaccine. Considerations include the needs of the healthcare sector and other critical infrastructure, infectiousness of the virus, the number of doses of vaccine required and the impact of the disease on different populations. Contracts managed by the Australian Government provide for purchase of customised pandemic influenza vaccine in the event of a pandemic in Australia. Experience with pandemic (H1N1) 2009 was that customised vaccine uptake was not as high as initially predicted because of the perceived lack of severity of the pandemic. This vaccine may be provided in multi dose vials. This will be different to usual practice, where vaccines are generally single use vials in Australia—requiring both provider and consumer education / communication.

Timing

Customised vaccine is unlikely to be available until up to 6 months after initial identification of the viral strain and may post-date the first pandemic wave. Vaccines administered after this time may mitigate the impact of subsequent waves. Even with antecedent investments in vaccine capacity, it took 5 months for a matched strain-specific vaccine to be commercially available for response to the 2009 pandemic. Suppliers should be asked to commence development of a vaccine when a novel virus of concern is notified. Purchase of the vaccine should cease when an adequate supply is available, based on expert advice on level of population immunity and the risk of further transmission. Supply of vaccine would cease when virus circulation within the community is deemed as minimal.

P7: Seasonal influenza vaccine

Application

Seasonal influenza vaccine's capacity to protect against related influenza variants may be considered. Familiarity of the public with seasonal influenza vaccines will influence attitudes and behaviours. Existing seasonal influenza health system arrangements will be the basis for those used during the pandemic.

Objective and rationale

To reduce serious morbidity and mortality from influenza. During a pandemic, seasonal influenza vaccine may help to reduce the severity of illness in those that become infected, or prevent infection in some. Seasonal influenza vaccination primes the public for acceptability of a customised pandemic vaccine.

Evidence of effectiveness

Moderate for seasonal influenza; *minor* for a pandemic. The effectiveness of seasonal influenza vaccine depends primarily on the recipient's age and immunocompetence and the similarity between the virus strains in the vaccine and those circulating in the community.²⁴ An Australian hospital-based surveillance study conducted in sentinel hospitals found vaccination was moderately protective against hospitalisation with influenza in the 2010/2011 seasons (estimated crude vaccine effectiveness was 57%).²⁵ Limited evidence shows that a seasonal vaccine sharing at least the neuraminidase component with an emergent pandemic strain may provide some measure of clinical cross-protection. Receipt of seasonal influenza vaccine can block the acquisition of natural immunity resulting from influenza infection, potentially making recent recipients of seasonal vaccine more vulnerable to pandemic virus strains.

Risks and benefits

Risks: Seasonal vaccines do not offer full protection against the circulating seasonal virus strain. Possible adverse events including swelling and redness at the injection site; low-grade fever, malaise and myalgia; fever and febrile convulsions in children. During a pandemic, in relatively immunologically naive children, seasonal influenza vaccines do not induce cross-reactive antibodies.

Benefits: Seasonal vaccines protect not only individuals but also others in the community by increasing the overall immunity in the population and thus minimising the spread of infection. After vaccination, most adults develop antibody levels likely to protect them against the strains of virus represented in the vaccine. There is also likely to be protection against related influenza variants.²⁴ Acceptability of seasonal influenza vaccination as routine is likely to increase public acceptance of pandemic influenza vaccine. During a pandemic, in adults historically exposed to influenza virus strains that are partially matched to the emergent pandemic strain, seasonal vaccines may boost cross-reactive antibody, providing partial protection.

Direct costs

Moderate to high. Costs include purchase, distribution and administration of vaccine; including management of purchasing contracts and monitoring of contracted market share arrangements. Other costs are coordination of a vaccination program, including development of clinical advice, development/ dissemination of communications materials, briefing of ministers and responding to media queries.

Secondary costs

Moderate. Costs include promotion of the seasonal influenza immunisation program, monitoring and managing vaccine adverse events, and monitoring uptake and effectiveness of the vaccine.

Likely acceptability and expectations

Acceptability is generally high.

Practicalities and experience

Existing arrangements are in place under the National Immunisation Program for the purchase, distribution and administration of seasonal influenza vaccine to at-risk groups. Multipartite contracts exist between suppliers, state and territories, and the Australian Government for the purchase of seasonal influenza vaccine. In a pandemic, the impact levels of the pandemic and the likely effectiveness of the seasonal vaccine against the pandemic strain would need to be considered.

Timing

Vaccination is best undertaken in autumn, in anticipation of winter outbreaks of influenza. The National Influenza Program commences on 15 March each year. Vaccine is available earlier for use in the northern areas of Queensland, Western Australia and the Northern Territory, where the seasonality of influenza differs slightly from the southern states, resulting in an early rise of cases prior to the winter influenza season. As full protection is usually achieved within 10–14 days, and there is evidence of increased immunity within a few days, vaccination can still be offered to adults and children after influenza virus activity has been documented in the community.²⁴

References

1. Australian Commission on Safety and Quality in Healthcare, National Health and Medical Research Council. Australian guidelines for the prevention and control of infection in healthcare. In. Canberra: NHMRC; 2010.
2. World Health Organization. WHO guidelines on hand hygiene in health care. Geneva; 2009.
3. Cowling BJ, Chan KH, Fang VJ, Cheng CK, Fung RO, Wai W, et al. Facemasks and hand hygiene to prevent influenza transmission in households: a cluster randomized trial. *Annals of Internal Medicine* 2009;151(7):437–446.
4. Savolainen-Kopra C, Haapakoski J, Peltola PA, Ziegler T, Korpela T, Anttila P, et al. Hand washing with soap and water together with behavioural recommendations prevents infections in common work environment: an open cluster-randomized trial. *Trials* 2012;13:10.
5. Hubner NO, Hubner C, Kramer A. Impact of health campaign on hand hygiene with alcohol-based hand rubs in a non-clinical setting. *J Hosp Infect* 2013;83(suppl. 1):S23–28.
6. Kuster SP, Shah PS, Coleman BL, Lam PP, Tong A, Wormsbecker A, et al. Incidence of influenza in healthy adults and healthcare workers: a systematic review and meta-analysis. *PLoS ONE* 2011;6(10):e26239.
7. Gunaratnam P, Tobin S, Seale HS, McAnulty J. Airport arrivals screening during pandemic (H1N1) 2009. North Sydney; 2013.
8. Bell DM, World Health Organization Working Group on Prevention of International and Community Transmission of SARS. Public health interventions and SARS spread, 2003. *Emerg Infect Dis* 2004;10(11):1900–1906.
9. Fraser C, Riley S, Anderson RM, Ferguson NM. Factors that make an infectious disease outbreak controllable. *Proceedings of the National Academy of Sciences of the United States of America* 2004;101(16):6146–6151.
10. Selvey L, Hall R, Antão C. Development of an evidence compendium and advice on travel-related measures for response to an influenza pandemic and other communicable diseases. In: Curtin University, editor.: Australian Government Department of Health; 2013.
11. Cooper BS, Pitman RJ, Edmunds WJ, Gay NJ. Delaying the international spread of pandemic influenza. *PLoS Med* 2006;3(6):e212.
12. World Health Organization. WHO global influenza preparedness plan. Geneva; 2005
13. World Health Organization. International health regulations (2005). Geneva; 2005.
14. Germann TC, Kadau K, Longini Jr IM, Macken CA. Mitigation strategies for pandemic influenza in the United States. *Proceedings of the National Academy of Sciences of the United States of America* 2006;103(15):5935–5940.
15. Ferguson NM, Cummings DA, Fraser C, Cajka JC, Cooley PC, Burke DS. Strategies for mitigating an influenza pandemic. *Nature* 2006;442(7101):448–452.
16. Kavanagh A, Mason K, Bentley R, Studdert D, McVernon J, Fielding J, et al. Leave entitlements, time off work and the household financial impacts of quarantine compliance during an H1N1 outbreak. *BMC Infect Dis* 2012;12(1):311.
17. Wu JT, Cowling BJ, Lau HYL, Ip DKM, Ho L, Tsang T, et al. School Closure and Mitigation of Pandemic (H1N1) 2009, Hong Kong. *Emerg Infect Dis* 2010;16(3):538–541.
18. Verikios G, McCaw JM, McVernon J, Harris AH. H1N1 influenza and the Australian macroeconomy. *J Asia Pac Econ* 2012;17(1):22–51.
19. Kumar S, Quinn SC, Kim KH, Daniel LH, Freimuth VS. The impact of workplace policies and other social factors on self-reported influenza-like illness incidence during the 2009 H1N1 pandemic. *American Journal of Public Health* 2012;102(1):134–140.
20. World Health Organization. Recommended composition of influenza virus vaccines for use in the 2013–2014 northern hemisphere influenza season. Geneva; 2013.
21. Van Kerkhove MD, Vandemaële KA, Shinde V, Jaramillo-Gutierrez G, Koukounari A, Donnelly CA, et al. Risk factors for severe outcomes following 2009 influenza A (H1N1) infection: a global pooled analysis. *PLoS Medicine* 2011;8(7):e1001053.
22. McVernon J. Evidence and advice on candidate pandemic influenza vaccines for response to an influenza pandemic. Canberra: DoHA; 2013.
23. Australian Government Department of Health and Ageing. Review of Australia's health sector response to pandemic (H1N1) 2009. In. Canberra: DoHA; 2011.
24. Australian Government Department of Health and Ageing. The Australian immunisation handbook. Canberra; 2013.
25. Cheng AC, Holmes M, Irving LB, Brown SG, Waterer GW, Korman TM, et al. Influenza vaccine effectiveness against hospitalisation with confirmed influenza in the 2010–11 seasons: a test-negative observational study. *PLoS ONE* 2013;8(7):e68760.

Attachment F. Guide to Implementation

Guide to Implementation

This document shows which measures from the Menu of Actions are relevant for each stage of the AHMPPI. For the Targeted Action Stage it also considers which measures might be applied in three scenarios representing different levels of impact a pandemic might have on the community. (See Pandemic Impact section of Governance Chapter for more information.) These scenarios are described as:

Scenario one

If clinical severity is low

The majority of cases are likely to experience mild to moderate clinical features. More severe illness may be experienced by people in at-risk groups. At the peak of the pandemic, and increasingly when transmissibility is higher, primary care and hospital services are likely to be stretched to coping capacity in areas associated with respiratory illness and acute care. Existing legislation is likely to be sufficient to support activities. The level of impact on the community may be similar to severe seasonal influenza or the H1N1 pandemic 2009.

Scenario two

If clinical severity is moderate

Young healthy people and people in at-risk groups may experience severe illness. The number of people presenting for medical care is likely to be higher than for severe seasonal influenza and primary care and hospital services will be under severe pressure, particularly in areas associated with respiratory illness and acute care. Non-urgent procedures and activities will need to be scaled back. Surge staffing and alternate models of clinical care, such as flu clinics may need to be employed to cope with increased demands for healthcare. Pressure on health services will be more intense, rise more quickly and peak earlier as the transmissibility of the disease increases.

Strategies to support at-risk groups may be required (e.g. aged care, Aboriginal and Torres Strait Islander peoples, remote communities). Pandemic emergency legislation may be needed to support pandemic specific activities. The level of impact may be similar to the 1957 Asian flu.

Scenario three

If clinical severity is high

Widespread severe illness will cause concern and challenge the capacity of the health sector. Areas such as primary care, acute care, pharmacies, nurse practitioners and aged care facilities will be fully-stretched to support essential care requirements. Heavy prioritisation will be essential within hospitals in order to maintain essential services and mortuary services will be under pressure. The demand for specialist equipment and personnel is likely to challenge capacity. Staff absenteeism will compound these difficulties. Pressure on health services will be more intense, rise more quickly and peak earlier as the transmissibility of the disease increases.

Secondary care services, such as blood services will be challenged to maintain capacities and the community focus will be on maintaining essential services. Pandemic emergency legislation may be needed to support pandemic specific activities. The level of impact may be similar to the 1918 Spanish flu.

In the table below, it is recommended that measures should be considered for implementation when the background of the cell is coloured. General practicalities which apply to this measure across all stages of the AHMPPI are addressed in the far right column. Comments specific to the use of a measure in one particular stage only are included in the coloured cell appropriate for the column representing that stage.

The definition of contacts in healthcare setting will be as per Influenza Infection: CDNA National Guidelines for Public Health Units (July 2011), unless alternate advice is issued at the time of the pandemic. Advice regarding the definition of contacts for the purposes of contact tracing, provision of prophylaxis and advice will be provided by CDNA at the time of the pandemic.

If the Menu of Actions recommends that an action as a whole should not be used, it has not been included in the Guide to Implementation.

Abbreviations used:

Comms = communications

CS = clinical severity

HCW = Healthcare workers

meas. = measures

PPE = gowns, gloves, masks

Table 7: Guide to Implementation Pharmaceutical measures

Measures	Preparedness	Standby	Initial Action	Targeted Action: Low CS	Targeted Action: Moderate CS	Targeted Action: High CS	Standdown	Practicalities
Antivirals: treatment	Used for seasonal influenza	As for seasonal influenza	Treat cases if appropriate	Move away from treating mild cases to protecting those at risk of severe outcomes	Delivery capacity will become an issue	Delivery capacity will become an issue	Cases as required by condition	Use for all cases Effectiveness strongly dependent on timely delivery and compliance. Risk of stockpile depletion with widespread distribution.
Antivirals: post-exposure prophylaxis			close contacts, possible at-risk contacts, HCW	contacts at risk of severe illness	close contacts & HCW increasingly as CS rises,	contacts at risk of severe illness, close contacts, contacts at high risk of severe illness, HCW (depending on exposure risk) Delivery capacity will become an issue		
Antivirals: pre-exposure prophylaxis						Control of the pandemic is most likely when CS is high + transmissibility is low		
Candidate vaccine						HCW (depending on exposure risk)		Unlikely to offer full protection. Useful if pandemic strain and candidate are same subtype. Possible adverse events.
Customised pandemic vaccine						It is important to include transmissibility in any risk assessment.	At-risk groups	Not initially available. Access is a key goal of the response
						Transmissibility and the associated level of population immunity achieved at the time of vaccine availability will need to be considered in decisions for use of customised vaccine.		

Table 8: Guide to Implementation for Social Distancing measures

Measures	Preparedness	Standby	Initial Action	Targeted Action: Low CS	Targeted Action: Moderate CS	Targeted Action: High CS	Standdown	Practicalities
Cancel mass gatherings						consider		High impact on businesses
Proactive school closures						consider		High impact on workplace absenteeism
Reactive school closures			In the presence of differentially higher transmissibility in children, the impact of school closures is likely to be greater.					High impact on workplace absenteeism
Workplace closures						Substantial costs to businesses and employees; disruption of services and supplies		Potential for high costs to employees from lost work days.
Home working								Not feasible for all
Voluntary isolation of cases				Disruption to workplaces and the economy	Disruption to workplaces and the economy	Disruption to workplaces and the economy		Household contacts at-risk of infection
Voluntary quarantine of contacts			Control of the pandemic is most likely when CS is high + transmissibility is low					Impact is dependent on early application Compliance is dependent on information and understanding of patients/ contacts.
Contact tracing			Essential for early surveillance activities			Benefits are most likely if disease severity is high. Continue in Targeted Action if CS is high and case identification is effective.		Impact depends on early application

Table 9: Guide to Implementation for Border measures

Border Measures	Preparedness	Standby	Initial Action	Targeted Action:	Targeted Action: Moderate CS	Targeted Action: High CS	Standdown	Practicalities
In-flight messages		Encourage awareness and appropriate behaviours	Relevant for all levels of transmissibility.					Low cost Promotes prompt presentation
Comms materials for travellers								Relatively low cost Promotes prompt presentation
Exit screening			Consider use if virus emerges first in Australia					High cost. May be recommended under IHRs. Consider upon request. Evidence does not support effectiveness

Table 10: Guide to Implementation for Infection Control measures

Measures	Preparedness	Standby	Initial Action	Targeted Action:	Targeted Action: Moderate CS	Targeted Action: High CS	Standdown	Practicalities
Organisational infection control measures: patient			Isolate suspected confirmed patients	Isolate/cohort suspected/confirmed patients	Isolate/segregate patients Consider clinical care models e.g. flu clinics	Isolate/segregate patients in the practice or ward Flu clinics or separate sites at hospitals		Surgical masks for patients Patients self-identify
			The intensity of infection control measures increases as transmissibility increases.					
Organisational infection control measures: staff			Separate flu and non-flu staff if possible or required	Cohort staff	Cohort staff	Cohort staff		Stay home if sick Vulnerable staff—avoid flu patients, ensure appropriate PPE.
PPE for healthcare workers	Used as part of national infection control guidelines		The intensity of infection control measures increases as transmissibility increases.					Use as per national infection control guidelines. Effectiveness dependent on compliance/ correct usage. Contact and droplet precautions plus eye protection. Airborne precautions for aerosol generating procedures.
Public messages re: hygiene etc.	Used for seasonal influenza		Relevant for all levels of transmissibility.					Empowers individuals Needs to be in line with seasonal approach Relevant for all levels of transmissibility.
Public messages re: situation and response efforts			Relevant for all levels of transmissibility.					Builds public confidence

Attachment G. Surveillance Plan

The Surveillance Plan for Pandemic Influenza

Office of Health Protection
Australian Government Department of Health

29 October 2013

1. Introduction	171
1.1. Surveillance data.....	171
1.2. Surveillance systems	172
1.3. Surveillance activities by pandemic stage	172
1.4. Roles and responsibilities	174
Jurisdictional responsibilities	174
National responsibilities	175
Laboratories	175
Other surveillance systems.....	175
Researchers	175
1.5. Surveillance reporting	175
1.6. Flexibility of the Plan to adapt to a different disease threat.....	175
1.7. Additional studies.....	176
2. Preparedness	177
2a. Monitor:.....	177
2b. Investigate:.....	178
3. Standby.....	180
4. Action	183
4a. Initial Action.....	183
4b. Targeted Action	185
5. Standdown.....	187

1. Introduction

The Surveillance Plan for Pandemic Influenza (the Plan) is intended to guide national surveillance activities in the event of a pandemic to ensure the collection of useful, consistent, representative and high quality data and enable informed decision making by public health officials. The Plan uses seasonal systems as its foundation and progresses through defined stages that support the changing requirements of decision makers throughout a pandemic.

This is an evolving document that will be updated over time based on changes to surveillance systems and, in some cases, changes to the underlying assumptions based on emerging research. Some operational aspects of the Plan, such as the mechanisms involved in initiating additional studies and refining the enhanced data forms, will also be clarified over time.

Operational details supporting the goals of the Plan are described in the Pandemic Influenza Surveillance Operational Guide which includes such things as a description of seasonal systems, pandemic planning assumptions, data collection matrices and case and contact interview forms with accompanying data dictionary.

1.1. Surveillance data

Data collected through influenza surveillance systems largely fall into four main categories:

- epidemiology;
- indicators of public health impact; and
- virology.

Information from these categories is used to inform the actions of decision makers both throughout a typical influenza season and during a pandemic.

In the Plan, case information such as core demographic data (e.g. age, sex, Indigenous status, location of residence or onset date), symptoms, occupation, risk factors, comorbidities, travel history and vaccination status will be referred to as the epidemiology.

Information on the clinical spectrum of illness, as well as transmission characteristics, is required in order to predict the likely public health impact and time course of a pandemic. This information will inform the appropriate scale of response. Virology covers all aspects of genome analysis, particularly analyses looking for markers of virulence and transmissibility, antigenic characterisation of the virus, as well as assessment of antiviral susceptibility. Characterisation of the virological features of the novel virus will guide the development of vaccines, diagnostic tests and direct treatment decisions. Additionally, animal models of influenza transmission will also inform the relative ease of direct contact and aerosol transmission compared to seasonal influenza.

1.2. Surveillance systems

Australia’s key pandemic preparedness strategy is to utilise existing systems wherever possible to implement the response, rather than initiating pandemic specific systems. This approach should enable the rapid and efficient availability of surveillance systems in the event of an influenza pandemic and provide baseline seasonal data to inform the impact of the event. Familiarity with already established systems will also foster timeliness and confidence of use and minimise the need for “just in time” training.

A suite of national and sentinel influenza surveillance systems has been established to collect data on the epidemiology, clinical disease and virology of seasonal influenza (see Pandemic Influenza Surveillance Operational Guide for a description of these systems). During a pandemic, these established systems may be modified or expanded according to the requirements of decision makers and the pandemic stage.

1.3. Surveillance activities by pandemic stage

The Plan describes staged surveillance activities undertaken for the identification and response to novel influenza viruses infecting humans. This approach has been based on emergency management principles, and will support the changing requirements of decision makers throughout a pandemic (Tables 1 and 2).

Figure 9: Model of Pandemic Stages



During the *Preparedness stage*, influenza surveillance activities are designed to monitor and describe human infections with seasonal influenza and support the detection, understanding and response to novel influenza viruses. This stage cycles between the following situations:

- *Monitor*: monitoring, capacity building, maintenance and exercising of capacities; and
- *Investigate*: investigation when a novel virus infecting humans is identified and shows sporadic or limited human-to-human transmission.

During the *Preparedness stage*, surveillance activities will focus on laboratory testing, epidemiological investigations, contact tracing and local prevention and control measures in affected locations in an effort to understand the source of infection and control the outbreak. Identification of sporadic and limited clusters of cases in Australia or overseas, even those involving apparent limited human-to-human transmissions, do not constitute a sufficient risk to trigger transition to pandemic surveillance actions. Should the novel infection not progress to sustained community human-to-human transmission monitoring of the situation will continue.

Table 11: Surveillance in the Preparedness stage

Stage	Preparedness	
	Monitor	Investigate
Trigger	Syndromic and virological surveillance trends show normal seasonal pattern.	Identification of a novel virus.
Aim	Build, maintain and exercise capacities.	Understand the epidemiology and virology of the virus to inform the initial national actions. Detect cases in Australia. Identify sustained community human-to-human transmission (local or international). ⁵



Standby

Sustained community human-to-human transmission detected.

During a pandemic, surveillance aims will transition from a focused understanding of the epidemiology of the disease overseas, through detection of the virus in Australia, to detailed investigation of the epidemiology of the disease and finally monitoring the progress of the pandemic.

⁵ If sustained community person to person transmission is not detected, monitoring of the situation will continue.

The *Standby* stage is triggered by confirmation of sustained human-to-human in the community irrespective of location. Sustained community human-to-human transmission significantly raises the potential of the virus to negatively impact Australia in the short term. Detection of the first case in Australia could be used to escalate the AHMPPI to the *Initial Action* stage.

Once sufficient enhanced data have been collected during the *Initial Action* stage, the Plan will move to a *Targeted Action* stage until community transmission of the pandemic virus returns to seasonal-type levels.

Table 12: Surveillance in the Standby, Action and Standdown stages

Stage	Standby	Action		Standdown
		Initial	Targeted	
Trigger	Sustained community human-to-human transmission detected overseas.	Detection of cases in Australia. ⁶	Sufficient data collected to describe the pandemic.	Public health threat can be managed within normal arrangements and monitoring for change is in place.
Aim	Detect initial cases in Australia.	Understand epidemiology within Australian context to inform targeted action.	Monitor course of pandemic and assess actions.	Monitor for reappearance. Evaluate actions.

The remaining sections of the Plan will discuss the surveillance aims, what data will be collected, how the data collected will inform actions to the pandemic virus and the expected level and frequency of surveillance reporting by audience for each pandemic stage. Data collection activities are described in detail in the Pandemic Influenza Surveillance Operational Guide.

1.4. Roles and responsibilities

Clear accountabilities will support timely data collection and transfer to provide the most complete picture on clinical outcomes possible, including intervention effectiveness. The workload involved in following up cases and contacts is expected to be significant.

Jurisdictional responsibilities

Jurisdictions are primarily responsible for individual case data collection and timely reporting of surveillance data to the Australian Government. The purpose of data collection is to provide additional *information* on the epidemiology of the emergent virus to inform a national response, NOT as part of a case-targeted strategy for disease containment. Collection of case and contact data, including enhanced data of early cases, during a pandemic is therefore to be undertaken *in parallel* with the core responsibilities of the Public Health Units (PHUs) concerning appropriate management of cases and their household contacts.

National responsibilities

Collation and interpretation of the pandemic-associated dataset is a national responsibility. The decision to cease enhanced data collection will be a national recommendation, based on a sufficiently precise determination of epidemic characteristics to allow strategic and optimised refocusing of response activities.

The Office of Health Protection (OHP) in the Australian Government Department of Health will facilitate development of data transfer processes and will feed the results of analyses back to the jurisdictions and through to decision makers and national bodies, including the CDNA and the AHPPC.

Laboratories

The WHOCC, National Influenza Centres (NICs) and PHLN will develop diagnostic laboratory testing protocols as well as providing notification data, data on testing activity and virological surveillance.

Other surveillance systems

During an influenza pandemic, surveillance data will be provided to the Australian Government Department of Health by other contracted providers including the Australian Sentinel Practices Research Network (ASPREN), the Influenza Complications Alert Network (FluCAN), FluTracking and the Australian Paediatric Surveillance Unit (APSU).

Researchers

Other jurisdictional and non-Government groups will contribute additional pandemic data, analysis and advice through additional studies.

1.5. Surveillance reporting

Reporting of surveillance trends will be determined by the incident stage. A comprehensive communications policy will be implemented across all aspects of the AHMPPI and will be a key component in the successful response to an influenza pandemic. The communications policy is described in detail elsewhere.

1.6. Flexibility of the Plan to adapt to a different disease threat

Selected existing national and sentinel influenza surveillance systems are flexible enough to rapidly adapt to a communicable disease threat other than influenza. At a minimum, community-level illness (e.g. FluTracking), GP presentation data (e.g. ASPREN), hospitalisation data (e.g. FluCAN) and notification data (NetEpi) could be collected through existing systems by modification or addition of queries based on the symptoms and virology of the disease. More comprehensive changes can also be made but would require longer development time.

1.7. Additional studies

During an influenza pandemic, routine surveillance data will need to be supported by additional targeted research studies. The public health activities initiated by the first case detected in Australia will be initially guided by observations from the country of origin and the pandemic assumptions described in the Pandemic Influenza Surveillance Operational Guide. This will identify risk factors for infection and illness, including specific age groups and predicted sensitivity or resistance to antiviral drugs, which are critical for guiding the national response. As the pandemic progresses within Australia, measures of population health impact, epidemiology and virology will drive the response. Detailed epidemiological studies and the enhanced data-set will be interrogated to assess whether the pandemic assumptions are valid.

A few outbreak studies should be conducted early in school and other institutional settings, with swabbing of exposed individuals to allow identification of asymptomatic and mild secondary cases, and investigation of transmission chains to determine serial interval and effective reproductive number (R_{eff}) in those settings. Jurisdictional PHUs are not responsible for investigating situational outbreaks such as those which occur in schools.

2. Preparedness

Preparedness is an ongoing state during which the goal is to establish arrangements and update capacities to improve responses to the next emergence of a novel influenza virus infecting humans. The Preparedness stage can be considered to cycle between two situations, monitor and investigate.

2a. Monitor:

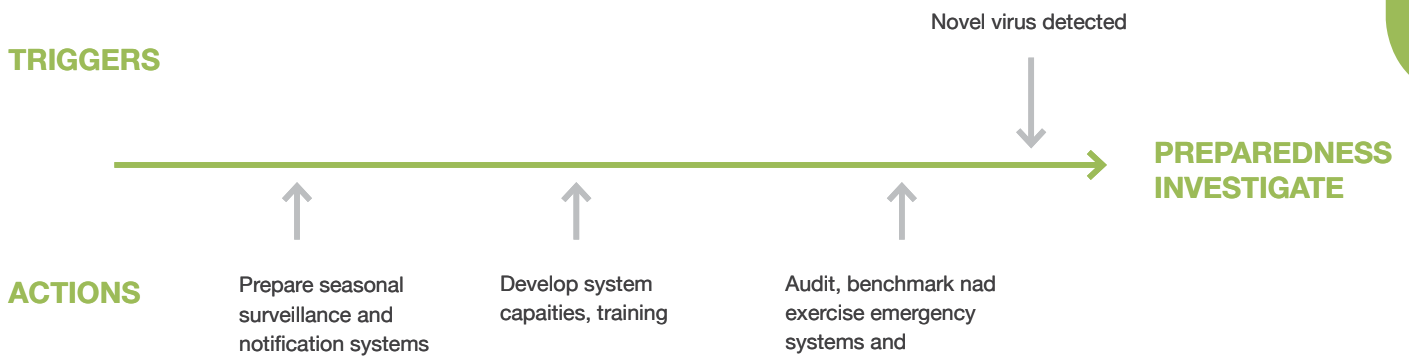

Trigger for monitoring

Syndromic and virological surveillance trends show normal seasonal pattern.

Surveillance aims

- Build, maintain and exercise surveillance systems and capacities capable of detecting and monitoring human influenza infections.

Surveillance activities

- Develop performance standards.
- Benchmark systems and staff against performance standards.
- Establish and maintain inter-agency relationships.

2b. Investigate:

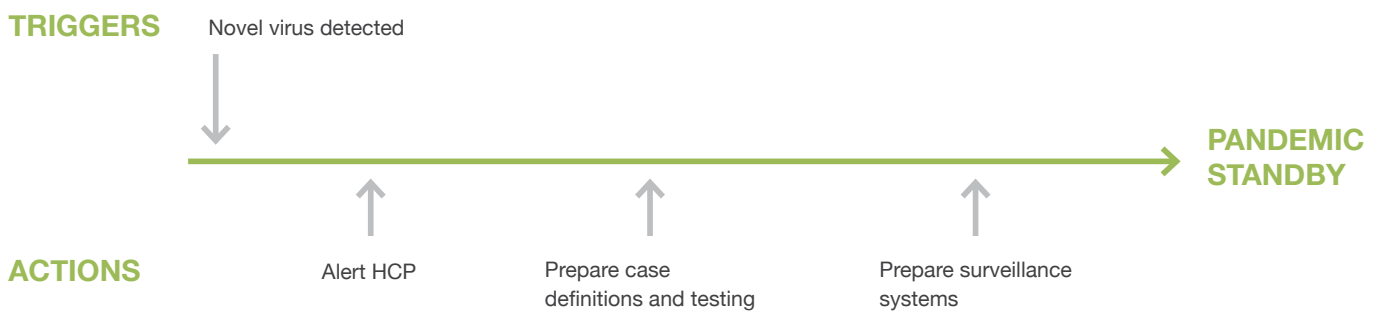

Trigger for monitoring

Identification of a novel virus in Australia or overseas.

Surveillance aims

- Understand the epidemiology and virology of the virus to inform the initial national actions.
- Detect cases in Australia.
- Identify sustained, community human-to-human transmission (local or international).

Surveillance activities

- Prepare to detect cases in Australia.
- Increase Health Care Professional (HCP) awareness.
- Develop necessary laboratory capability.
- Adapt and implement case notification system.
- Assess and prepare sentinel and syndromic surveillance systems and studies.
- Analyse and report observed epidemiology and virology.

Routine monitoring for the emergence of novel agents, requires surveillance systems that are sufficiently powered to characterise the threat posed to Australia.

Identification of a novel influenza virus capable of infecting and causing disease in humans would be reported to the National Incident Room (NIR). The NIR is Australia's designated National Focal Point (NFP) under the terms of the International Health Regulations (2005).

- The case definition will be based on **virology** of the novel virus (for a confirmed case) and the **epidemiology** as per information available from the WHO and affected countries. The key demographic information to inform the case definition will be the countries, or regions of countries, with community transmission of the novel virus. Other case information that may inform the definitions includes indicators of transmissibility and risk to contacts, age, symptoms, clinical signs and symptoms, co-morbidities and risk factors.
- Some of the key surveillance systems (e.g. FluCAN and Flutracking) are only active during the influenza season. If a novel virus was identified overseas during the inter-seasonal period in Australia, those offline systems would be prepared to restart during this stage.

HCPs, particularly those in hospitals, emergency departments and ICUs will be alerted regarding the new threat and will be requested to undertake targeted testing based on the case definition and testing protocol and reporting of probable and confirmed cases to jurisdictional health departments.

National surveillance systems will be modified to capture sporadic probable and confirmed cases. Specific actions will likely include development of case and contact interview forms and implementation of data transfer protocols. Surveillance systems for influenza-associated hospitalisations and ICU admissions (FluCAN and the APSU) will be adapted for reporting confirmed adult and paediatric outbreak cases involving acute respiratory distress syndrome (ARDS) or pneumonia.

During an outbreak investigation, it may also be useful to:

- review border health surveillance protocols including incoming passenger contact tracing.
- liaise with the Australian Government Department of Agriculture regarding potential animal reservoirs and animal surveillance

Table 13: Reporting during Preparedness

Audience	Reporting
Minister's office	Summary of information on the emerging pandemic and the likely impact for Australia, as new information becomes available.
Decision makers	All information on the emerging epidemic/pandemic as it becomes available.

Trigger for exiting Preparedness: Transition from the *Preparedness* stage to *Standby* could be triggered by any of the following:

- receipt of surveillance data that indicates sustained community human-to-human transmission of the novel virus overseas; or
- a warning of a potential influenza pandemic received from WHO; or
- indications received from a jurisdiction that they may seek assistance under the AHMPPI to manage severe seasonal influenza; or
- an indication from CDNA of a trend in seasonal influenza which may overwhelm state and territory health systems.

3. Standby

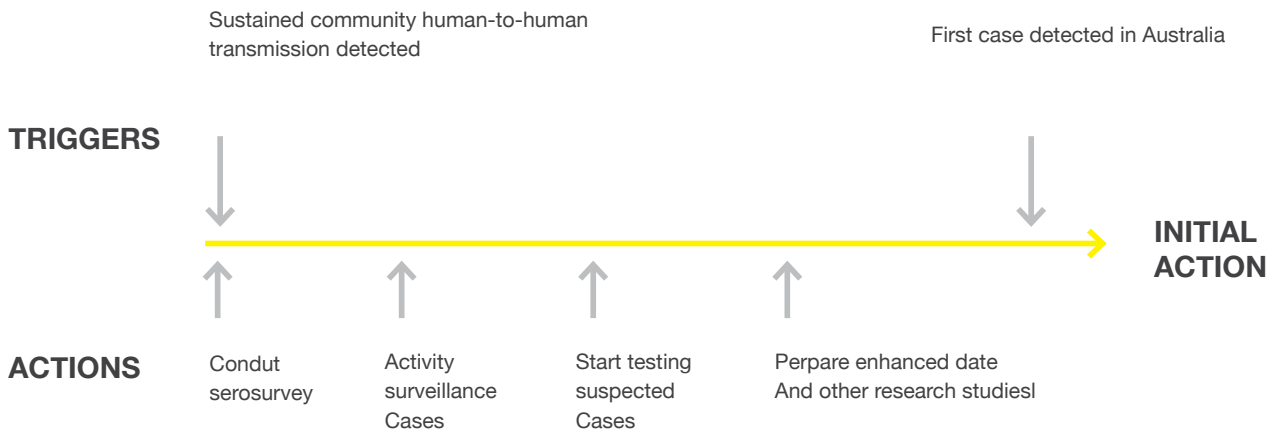

Triggers for entering Standby

- Sustained community human-to-human transmission detected; or
- a warning of a potential influenza pandemic received from WHO; or
- indications received from a jurisdiction that they may seek assistance under the AHMPPI to manage severe seasonal influenza; or
- an indication from CDNA of a trend in seasonal influenza which may overwhelm state and territory health systems.

Surveillance aims

- Detect initial cases in Australia

Surveillance activities

- Conduct expanded testing to detect the introduction of the virus to Australia and rapidly report early cases.
- Continue awareness raising activities targeted towards HCP.
- Identify testing capacity.
- Activate case notification system.
- Prepare to conduct enhanced data collections.
- Activate sentinel and syndromic surveillance systems for pandemic influenza surveillance.
- Prepare to conduct specified studies.
- Analyse and report international epidemiology and virology.
- If required, make the novel virus notifiable under relevant national and jurisdictional public health legislation.

Following the receipt of surveillance data that indicates that the novel virus is likely to negatively impact Australia in the short term, Australia’s response will transition to *Standby*.

Surveillance systems not already functioning will be activated and laboratory testing activity will be expanded through active case finding.

- The case definition will be refined as required.
- The preparation of established national and sentinel and enhanced surveillance systems to detect the introduction of the novel virus into Australia will be informed by available information on **transmissibility, epidemiology** and distribution of clinical **signs and symptoms** of confirmed cases overseas.

Decision makers will plan for implementing various interventions for reducing the impact of the virus on the Australian population, health system and economy, prior to the virus being detected in Australia (refer to the AHMPPI support documents for details). Interventions will be selected based on available information on the population health impact and transmissibility of the disease, and the **epidemiology** of cases from WHO and affected countries.

- Population health impact will be assessed by available information on symptoms and outcomes of cases, by age, as reported by the WHO and affected countries. It should be noted initial population health impact estimates will likely be skewed towards the severe end of the spectrum as these are the most likely to require contact with the health system and will be affected by socioeconomic factors and the health infrastructure in affected countries.
- Early indications of the extent of transmissibility will be based on any available information from WHO and affected countries and the assumptions given in the Pandemic Influenza Surveillance Operational Guide.

During Standby, activate border health surveillance protocols including incoming passenger contact tracing. Continue to liaise with the Australian Government Department of Agriculture regarding potential animal reservoirs and animal surveillance.

Table 14: Reporting during Standby

Audience	Reporting
Minister’s office	Summary of information on the emerging pandemic and the likely impact for Australia, as new information becomes available.
Decision makers	Analyses of surveillance data, including epidemiological, clinical and virological characteristics.

Trigger for exiting Standby: Transition from *Standby* to *Initial Action* may be triggered by any of the following indicators including:

- the first case being detected in Australia; or
- evidence of sustained community transmission of a novel virus which has emerged in Australia; or
- a declaration by WHO of an influenza pandemic; or
- a request for assistance with managing seasonal influenza from a jurisdiction.

If un-subtypeable cases of influenza A are detected during the *Standby* stage and laboratory tests for the novel virus were still being prepared, cases would be treated as probable and enhanced data collected.

4. Action

4a. Initial Action

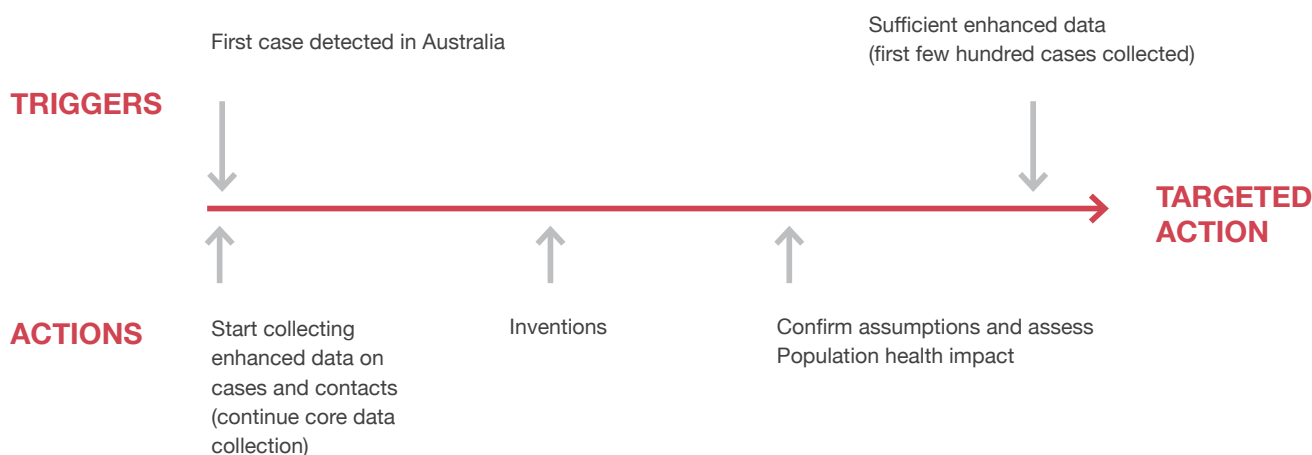

Trigger for entering Initial Action

Detection of cases in Australia; or
Evidence of sustained community transmission of a novel virus which has emerged in Australia; or
Declaration by WHO of an influenza pandemic; or
Request for assistance with managing seasonal influenza from a jurisdiction.

Surveillance aims

- Understand epidemiology within Australian context to inform targeted actions.

Surveillance activities

- Maintain HCP awareness.
- Maintain testing capability and monitor capacity.
- Maintain case notification system.
- Undertake enhanced data collection.
- Maintain sentinel and syndromic surveillance systems.
- Initiate and report outcomes of research studies.
- Analyse and report Australian and international epidemiology and virology.

Standby

Initial Action

In order to build a picture of the epidemiology of the disease in Australia, the State and Territory health departments will collect and feed detailed **demographic** data on the first few hundred cases and their contacts to the Australian Government Department of Health through an outbreak management system (e.g. NetEpi) for national collation, analysis and reporting. An enhanced data collection form and accompanying data dictionary based on existing NNDSS fields has been prepared and is described in the Pandemic Influenza Surveillance Operational Guide.

Probable and confirmed cases will be reported by the notifying jurisdiction. The decision to cease enhanced data collection will be based on the stability of trends in epidemiological and population health impact measures.

- **Population health impact** will be indicated by the number and rates of hospitalisations, ICU admissions and deaths from the enhanced data collection. Data on hospitalisations and ICU admissions will also be provided by sentinel hospitals through FluCAN. Data from sentinel systems will support the enhanced data and provide a comparator once the enhanced data collection ceases.
- **Transmission rate** will be estimated through studies (see section 1.7) and the enhanced dataset. Prior to the results of these studies being available, transmissibility will be based on overseas estimates and the pandemic assumptions (see Pandemic Influenza Surveillance Operational Guide).

Various interventions for containing the spread of the virus or reducing population health impact may be implemented by decision makers during this stage (see Attachment E of the AHMPPI for the menu of options). Interventions will be selected, refined, and discontinued based on the **epidemiology** and the observed health impact of the virus in Australia, both in terms of clinical outcomes and transmissibility.

During *Initial Action*, border health surveillance protocols will be reviewed and maintained including incoming passenger contact tracing. Liaison activities with the DA regarding potential animal reservoirs and animal surveillance will continue.

Table 15: Reporting during Initial Action

Audience	Reporting
Minister's office	Counts of cases, hospitalisations, ICU admissions and deaths. Information on populations at risk of infection or severe disease. <u>Note:</u> This is the only pandemic surveillance stage in which these counts will be reported as they will be available from the enhanced data set.
Decision makers	Analyses of surveillance data, including epidemiological, clinical and virological characteristics.

Trigger for exiting Initial Action: The decision making process for ceasing enhanced case data will be outlined in the detailed methodology currently under development. Broadly, once the dataset has been deemed to have reached a relatively stable point, with the first few hundred cases covered, and the population health impact of the virus has been determined (or is in the process of being determined through academic studies), enhanced data collection will cease and the Plan will move to *Targeted Action*.

4b. Targeted Action

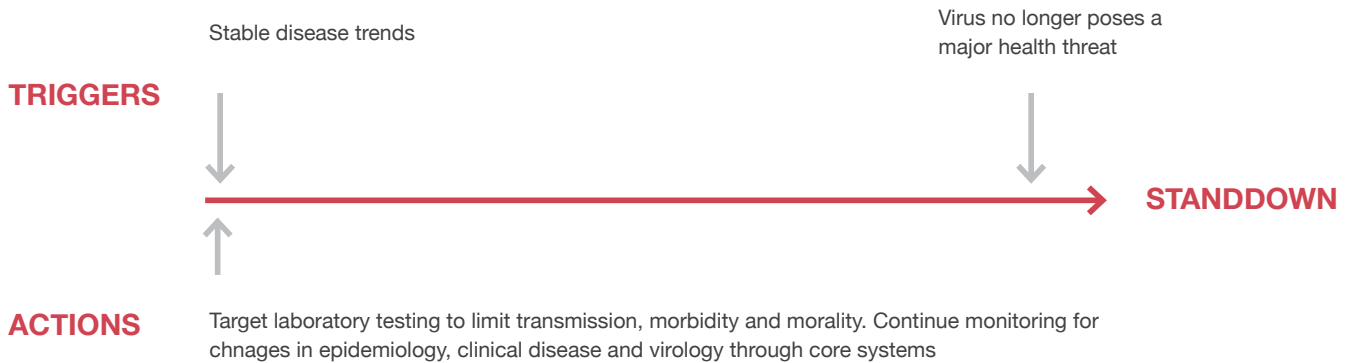

Trigger for entering Targeted Action

Sufficient data collected to describe the pandemic in Australia and to inform refinement of the pandemic response measures already implemented.

Surveillance aims

- Monitor course of pandemic and assess actions.

Surveillance activities

- Monitor for changes in epidemiology and virology.
- Maintain HCP awareness.
- Monitor and maintain targeted testing capacity.
- Maintain case notification system.
- Undertake limited ongoing enhanced data collection.
- Maintain sentinel and syndromic surveillance systems and studies.
- Analyse and report Australian and international epidemiology and virology.

During this stage, community transmission of the pandemic virus will likely become widespread across Australia. The main surveillance aim during this stage is to continue collecting core data from established surveillance systems to detect any changes in the **epidemiology** of those getting sick, the **clinical disease manifestations** of the disease or the characteristics of the virus (including the virology).

Throughout this stage, laboratory testing will be targeted towards more clinically severe probable cases and those with risk factors. In order to reduce the impact on health systems, cases with less severe disease may no longer be recommended for laboratory confirmation or encouraged to limit their health care attendance.

Academic studies for testing assumptions with the enhanced data set will continue throughout this phase. All results will be provided to decision makers as they become available.

Liaison activities with the Australian Government Department of Agriculture regarding potential animal reservoirs and animal surveillance will continue.

Table 16: Reporting during Targeted Action

Audience	Reporting
Minister's office	<p>Summary of current situation based on notifications and surveillance systems.</p> <p>Frequency of reporting to be determined and will likely reduce towards the end of this stage as activity returns to relatively normal levels.</p> <p><u>Note:</u> enhanced data for cases, hospitalisations, ICU admissions and deaths will NOT be available during this stage; trends and proportions will be reported.</p>
Decision makers	Analyses of surveillance data, including epidemiological, clinical and virological characteristics.

Trigger for exiting Targeted Action: Individual activities will be assessed and stood down when they no longer contribute to the AHMPPI's goals. The AHMPPI as a whole will move to Standdown when advice from CDNA indicated that the pandemic has reached a level where it can be managed under seasonal influenza arrangements.

5. Standdown

Trigger for entering Standdown

When the public health threat can be managed within normal arrangements and monitoring for change is in place.

Surveillance aims

- Evaluate actions and monitor for reappearance.

Surveillance activities

- Monitor for change in virus activity or potential new wave.
- Maintain HCP awareness.
- Maintain and monitor targeted testing capacity.
- Maintain case notifications system.
- Cease enhanced data collection.

During this stage, influenza activity returns to levels typical for the time of year. Surveillance and reporting activities will proceed as appropriate for the time of year.

The main surveillance aim during this stage is to assess the risk of secondary waves and to review the response.

Results from data analysis and any lessons learnt during the pandemic should inform a revised AHMPPI and Plan during *Prepare*.

Trigger for exiting Standdown: Once influenza activity returns to typical seasonal levels the Plan will move to *Preparedness*.

Attachment H. Evidence Compendium

The AHMPPI 2014 places an emphasis on flexibility and the tailoring of activities to the needs of the current situation. Part 3 of the AHMPPI supports decision makers in this process by providing a series of tools which contain additional detail about key issues and operational activities.

This Evidence Compendium, as a component of Part 3, contains a series of commissioned reports including literature reviews, modelling and an analysis of the assumptions underlying pandemic planning for the AHMPPI. The findings of these reports have been used to develop the approach taken in the AHMPPI, but as they may also be useful in their own right to provide greater detail of the evidence and analysis accumulated, they have been presented in this compendium in full.

These documents represent the best available information at the time of writing and will be periodically updated to ensure the evidence presented remains up to date.

Key findings from these reports relating to the effectiveness of individual public health measures have been made more readily accessible to decision makers by incorporating them into the Menu of Actions. This Menu provides decision makers with the key points to be considered when deciding whether to implement a specific measure.

A series of summaries have also been developed in which the key information from these reports has been brought together into each of the main thematic areas covered in the AHMPPI.

Commissioned reports

- Glass K, Davis S, Martich L, Mercer GN, *Development of decision support documents to assist decision making during a pandemic influenza response: evidence for personal protective equipment and antiviral measures*, Report commissioned by the Australian Government Department of Health and Ageing, Canberra, 2012.
- Martich L, Glass K, Mercer GN, Ross J, McVernon J, McCaw J, *Mathematical modelling and Research of Personal Protective Equipment for use in a Health Emergency*, Report commissioned by the Australian Government Department of Health and Ageing, Canberra, 2013.
- McCaw J, Moss R, McVernon J, Cheng A, *Review Current Evidence on the Use of Neuraminidase Inhibitors Held in the National Medical Stockpile, In A Pandemic, Reporting Deliverable 2*, Report commissioned by the Australian Government Department of Health, 2015.
- McVernon J, McCaw J, *Development of options on how to define the concept of pandemic impact for Australian purposes: Literature review*, Report commissioned by the Australian Government Department of Health and Ageing, Canberra, 2012.
- McVernon J, McCaw J, *Development of options on how to define the concept of pandemic impact for Australian purposes: Consultation and Workplan*, Report commissioned by the Australian Government Department of Health and Ageing, Canberra, 2012.
- McVernon J, McCaw J, *Development of options on how to define the concept of pandemic impact for Australian purposes: Report on simulation modelling*, Report commissioned by the Australian Government Department of Health and Ageing, Canberra, 2012.
- McVernon J, *Evidence and advice on candidate pandemic influenza vaccines for response to an influenza pandemic*, Report commissioned by the Australian Government Department of Health and Ageing, Canberra, 2013.

- McVernon J, McCaw J, *Mathematical modelling of antivirals for a public health response to an influenza pandemic Reporting Deliverable 1*, Report commissioned by the Australian Government Department of Health and Ageing, Canberra, 2013.
- McVernon J, McCaw J, *Mathematical modelling of antivirals for a public health response to an influenza pandemic Reporting Deliverable 2*, Report commissioned by the Australian Government Department of Health and Ageing, Canberra, 2013.
- McVernon J, McCaw J, *Mathematical modelling of antivirals for a public health response to an influenza pandemic Reporting Deliverable 3*, Report commissioned by the Australian Government Department of Health and Ageing, Canberra, 2013.
- McVernon J, Cheng A, McCaw J, Moss R, *Review Current Evidence on the Use of Neuraminidase Inhibitors Held in the National Medical Stockpile, In A Pandemic, Reporting Deliverable 1*, Report commissioned by the Australian Government Department of Health, 2015.
- McVernon J, Hurt A, *Review Current Evidence on the Use of Neuraminidase Inhibitors Held in the National Medical Stockpile, In A Pandemic, Reporting Deliverable 3*, Report commissioned by the Australian Government Department of Health, 2015.
- Rashid R, Ridda I, King C, Begun M, Tekin H, Wood JG, Booy R, *Evidence compendium and advice on social distancing and other related measures for response to an influenza pandemic*, Report commissioned by the Australian Government Department of Health and Ageing, Canberra, 2013. Review of pandemic planning assumptions (Australian Health Management Plan for Pandemic Influenza 2008/9, Department of Health and Ageing), 2012.
- Selvey L, Hall R, Antão C, *Development of an evidence compendium and advice on travel-related measures for response to an influenza pandemic and other communicable diseases*, Report commissioned by the Australian Government Department of Health and Ageing, Canberra, 2013.

Summaries

- Antivirals
- Assumptions
- Border measures
- Infection control
- Pandemic impact
- Pandemic vaccines
- Social distancing

Links to Menu of Actions entries

Infection control measures

- Communication strategies to improve public hand hygiene and cough/sneeze etiquette
- Personal protective equipment for workers in direct contact with symptomatic individuals
- Mask wearing by symptomatic individuals in the community

Border measures

- In-flight announcements/on-board announcements
- Communication materials
- Information for border staff

- Negative pratique
- Passenger locator documents
- Thermal scanners
- Border nurses
- Screening of passengers on cruise ships
- Voluntary isolation of ill travellers
- Voluntary quarantine of contacts of ill travellers
- Exit screening
- Internal travel restrictions

Social distancing measures

- Proactive school closures
- Reactive school closures
- Workplace closure
- Working from home
- Cancellation of mass gatherings
- Voluntary isolation of cases
- Voluntary quarantine of contacts
- Contact tracing

Pharmaceutical measures

- Antivirals for treatment of cases
- Antivirals for post-exposure prophylaxis of contacts
- Antivirals for post-exposure prophylaxis for at-risk groups
- Antivirals for pre-exposure prophylaxis for healthcare workers
- Candidate pandemic vaccine
- Customised pandemic vaccine
- Seasonal influenza vaccine

Attachment I. Governance Table

This table provides detailed guidance on roles and responsibilities. To meet the greater need for coordination and guidance at a national level in **Preparedness and Response**, this plan will focus primarily on these areas of activity.

The table below provides detailed guidance on the roles of the Australian Government and State and Territory Governments in the key areas of a combined public health and clinical response to support the outline provided in the Governance Chapter of this plan. It also identifies areas where governments will work together to:

- coordinate resources;
- provide guidance to support best practice implementation; and
- provide a consistent message to stakeholders and the broader community.

As this plan is intended to support government decision makers, this table focuses on the role of government. Government parties referred to in this table include, though involvement is not limited to, Australian Commission on Safety and Quality in Healthcare (ACSQHC), Australian Government Department of Health (Department of Health), Australian Technical Advisory Group on Immunisation (ATAGI), Communicable Disease Network Australia (CDNA), Chief Human Biosecurity Officers (CHBOs), the Department of Foreign Affairs and Trade, National Influenza Surveillance Committee (NISC), National Health and Medical Research Council (NHMRC), National Health Emergency Media Response Network (NHEMRN), Public Health Laboratory Network (PHLN), state and territory health departments (S/T HD) and the Therapeutic Goods Administration (TGA).

It is essential to recognise that other areas of the health sector will be integral to Australia's national response. A broad indication of the roles of other parts of the health sector has been included in this table to reinforce the importance of linkages with these areas.

Other health sector parties referred to in this table include, though involvement is not limited to, Aboriginal Community Controlled Health Services (ACCHSs), ambulance staff, paramedics and aeromedical retrieval, the Australasian College for Emergency Medicine (ACEM), General Practitioners (GPs), the Medical Technology Association of Australia (MTAA), Primary Health Networks (PHN), the nursing sector, the Royal Australasian College of Physicians, pharmacists, private and public hospitals (hosp) and laboratories (lab), Royal Australian and New Zealand College of Obstetricians and Gynaecologists (RANZCOG), residential aged care facilities (RACF), the WHO Collaborating Centre for Reference and Research on Influenza (WHOCC), and the WHO National Influenza Centres (NICs). (Other parties outside the health sector, such as the Department of Agriculture, airports, airlines, seaports and shipping agents may also need to be involved to support border measures.) This list is not intended to be complete, but to provide examples and guidance.

These tables represent activities within the **health sector only**. Responsible parties are identified within square brackets. In the other health sector parties column, it is assumed that comments relate to the majority of other health sector parties, unless specified.

To make it easier to relate activities to the stages of the AHMPPI the following colours have been allocated to each stage (as used throughout this plan):



Table 17: Roles and responsibilities of the Australian Government, State and Territory Governments and the health sector during the Preparedness stage.

Preparedness roles:	The Australian Government role is to:	The State and Territory Governments role is to:	The joint role of Australian Government and State and Territory Governments is to:	The role of other health sector parties is to:
Overarching role	Determine how national systems can be adapted or established to respond to an influenza pandemic. Formulate and maintain health care safety and quality standards and indicators. [ACSQHC]. Maintain the National Incident Room (NIR) (including staff, equipment, management systems).	Determine how systems can be adapted or established to respond to an influenza pandemic.	Provide strategic advice to governments and other key bodies on public health actions to minimise the impact of communicable diseases in Australia and the region [CDNA]. Develop and maintain guidance for public health units to respond to influenza infection (via the Series of National Guidelines (SoNGs) [CDNA]).	Prepare organisations to adapt to the demands and circumstances of an influenza pandemic. Participate in activities designed to prepare the health sector to respond to an influenza pandemic. Contribute to the development of guidelines, to ensure they are useful and easily understood across the health sector. Provide advice on the feasibility and impact of pandemic control measures.
Surveillance				
General surveillance	Establish and maintain systems to collate and analyse jurisdictional data to identify emerging national trends. Establish and maintain systems to collate and analyse international data to show emerging trends.	Establish and maintain systems to collect data to inform the jurisdictional public health response and contribute to identification of national trends.	Provide public health coordination of communicable disease surveillance [CDNA]. Establish and maintain mechanisms to discuss and advise on surveillance data that may indicate the threat of an influenza pandemic [CDNA].	Participate in influenza surveillance activities [GPs, labs, WHOCC, Aboriginal Health Workers, Emergency Departments (EDs)].

Preparedness roles:	The Australian Government role is to:	The State and Territory Governments role is to:	The joint role of Australian Government and State and Territory Governments is to:	The role of other health sector parties is to:
Seasonal influenza surveillance	Coordinate surveillance of the impact on Australia as a whole	Monitor data to identify when seasonal influenza has the potential to overwhelm the capacity of jurisdictional systems to manage the response. The jurisdiction may request assistance through AHPPC and NCC.	Consider requests for assistance to respond to a severe season of influenza [AHPPC]. Consider harmonisation of data collection and reporting [NISC].	Participate in routine influenza surveillance activities [GPs, Aboriginal Health Workers, EDs].
Pandemic influenza surveillance planning	Develop and maintain a national surveillance plan for pandemic influenza.	Provide input into development of a national surveillance plan for pandemic influenza.	Provide input into development of a national surveillance plan for pandemic influenza [[NISC/CDNA]. Consider and endorse a national surveillance plan for pandemic influenza [AHPPC].	Provide input into development of a national surveillance plan for pandemic influenza [through NISC].
Pandemic influenza surveillance	Monitor and investigate surveillance data for the emergence of potential influenza pandemics.	Monitor and investigate surveillance data for the emergence of potential influenza pandemics.	Consider and provide advice on surveillance data which may indicate the emergence of an influenza pandemic. Advise AHPPC if the data indicates a level of threat requiring action [CDNA].	Participate in influenza surveillance activities [GPs, Aboriginal Health Workers, EDs].
Groups at increased risk of influenza complications			Establish/advise on a national case definition for an at-risk individual for seasonal influenza (SoNGs) [CDNA].	Identify practice patients who are more likely to be at risk (e.g. GPs, ACCHSs, hospitals, RANZCOG, community health and aged care providers). Consider staff that may be at risk and possible methods of protection.

Preparedness roles:	The Australian Government role is to:	The State and Territory Governments role is to:	The joint role of Australian Government and State and Territory Governments is to:	The role of other health sector parties is to:
Planning				
Pandemic preparedness and response planning documents	Develop and maintain a national health sector plan to prepare for and respond to pandemic influenza. Develop and maintain plans to address the needs of special groups, such as aged care sector.	Participate in development of a national health sector plan. Develop and maintain jurisdictional plans relevant to an influenza pandemic. Develop and maintain plans to address the needs of special groups, such as Aboriginal and Torres Strait Islander peoples or immunocompromised people.	Assist with the development of a national health sector plan to prepare for and respond to pandemic influenza [CDNA/ATAGI/PHLN]. Consider and endorse the national health sector plan to prepare for and respond to pandemic influenza [AHPPC].	Provide input into the development of the national health sector plan, through professional associations and other representative bodies. Develop uniform templates that can be used for the clinical management of patients [hospitals, GPs].
Pandemic preparedness and response planning documents				Develop plans for emergencies relevant to the party e.g. incorporate planning for an influenza pandemic (or more broadly as part of emergency planning) into overall business plans and ensure they are reviewed and updated regularly (RACGP Managing Emergencies and Pandemics in General Practice: A Guide for Preparation, Response and Recovery is an example of guidance on this). Include human resource planning in business plans to ensure business viability during a pandemic response.

Preparedness roles:	The Australian Government role is to:	The State and Territory Governments role is to:	The joint role of Australian Government and State and Territory Governments is to:	The role of other health sector parties is to:
Whole of Government (WoG) pandemic plans	Participate in the development of WoG pandemic and emergency plans.	Participate in the development of jurisdictional WoG pandemic and emergency plans.	Provide input into the development of WoG pandemic and emergency plans.	Provide input into the development of WoG pandemic and emergency plans.
Infection Control				
Guidelines	Maintain infection control guidelines. [NHMRC].	Implement infection control guidelines.		Implement up-to-date infection control guidelines.
Personal Protective Equipment (PPE)	Assess requirement for a national PPE stockpile and maintain a stockpile appropriate to this determination.	Assess requirement for a jurisdictional PPE stockpile and maintain a stockpile appropriate to this determination.	Advise on appropriateness of PPE stockpiling [CDNA/PHLN].	Maintain respiratory hygiene products appropriate for infection control, and ensure that local agreements and arrangements are in place for stockpile requirements for PPE [e.g. GPs + nurses + hospitals + ambulance/paramedic organisations + ACCHSs + RACFs etc.].

Preparedness roles:	The Australian Government role is to:	The State and Territory Governments role is to:	The joint role of Australian Government and State and Territory Governments is to:	The role of other health sector parties is to:
Health Workforce				
GPs	Support promotion of feedback of GP Roundtable information regarding primary care into decision making fora.	<p>Work with PHN to</p> <ul style="list-style-type: none"> identify service gaps and vulnerable populations; and to support dissemination of communications and engagement in strategies. <p>Establish clear communication lines with health care providers both a state and local levels.</p>	Provide advice on management/treatment strategies and antiviral use.	<p>Support data collection and identification of gaps in services and vulnerabilities in patient populations relevant for their region [PHN + ACCHSs].</p> <p>Establish liaison and clear communication lines with other local health providers (such as pharmacists, community nurses, ambulance, hosp, mental healthcare workers, RACFs.)</p> <p>Advocate for and support the GP profession to plan and prepare for a pandemic, including through the RACGP Disaster Management Network [RACGP, NACCHO].</p>
Other health practitioners	Ensure involvement in planning and design of systems.	Ensure involvement in planning and design of systems.	Provide advice on management/treatment strategies and antiviral use [CDNA].	Support EDs in planning [relevant professional bodies]. Establish clear communication lines.

Preparedness roles:	The Australian Government role is to:	The State and Territory Governments role is to:	The joint role of Australian Government and State and Territory Governments is to:	The role of other health sector parties is to:
Primary healthcare providers	<p>Ensure involvement in planning and design of systems to respond to an influenza pandemic.</p> <p>Ensure inclusion of/ coordination with S/T HD when working with primary healthcare providers on pandemic issues.</p>	<p>Ensure involvement in planning and design of systems to respond to an influenza pandemic.</p> <p>Ensure inclusion of/ coordination with Health when working with primary healthcare providers on pandemic issues.</p>		Liaise and communicate with primary healthcare providers.
Immunisation	<p>Develop policy, procure vaccines and fund National Immunisation Program (NIP). This includes seasonal influenza vaccination program to support free vaccination for eligible Australians to protect against vaccine preventable diseases and communicate information related to the NIP to the general public and health professionals. Make arrangements with vaccine manufacturers to guarantee pandemic vaccine supply to Australia in the event of a pandemic.</p>	<p>Deliver NIP (including seasonal influenza program). Promote vaccination to the community. Educate vaccination services providers about influenza immunisation. Deliver vaccination services as appropriate.</p>	<p>Develop policy regarding immunisation during a pandemic or severe seasonal influenza outbreak, such as guidance for communications and coordinate implementation of state/territory immunisation programs. Plan resourcing required to implement use of vaccine [National Immunisation Committee]. Provide technical advice regarding pandemic influenza vaccine immunisation: priority groups; vaccination schedule and suitable vaccine [ATAGI].</p>	<p>Deliver NIP. Provide community education on the seasonal and pandemic immunisation program, led by local public health units [GPs, culturally and linguistically diverse (CALD) community groups, Aboriginal and Torres Strait Islander health sector].</p>

Preparedness roles:	The Australian Government role is to:	The State and Territory Governments role is to:	The joint role of Australian Government and State and Territory Governments is to:	The role of other health sector parties is to:
Adverse events following immunisation and antiviral use	Monitor the adverse events of antiviral drugs and pandemic vaccines and provide advice on safety of these products [TGA].	Report adverse events following immunisation to the TGA.	Consider adverse event profiles and advise on the use of vaccine/antivirals [ATAGI, CDNA].	Report adverse events following immunisation to the state health authority and/or TGA.
Medical Countermeasures Stockpiles				
Establish stockpiles	Establish and maintain national stockpile—see below.	Assess requirement for a jurisdictional stockpile and maintain a stockpile appropriate to this determination.	Provide advice regarding inventory of the stockpile, access to and use of stockpile items [AHPPC]. Establish written guidelines on use [CDNA].	Maintain stocks appropriate for infection control [GPs + hospitals + ambulance/paramedic organisations + ACCCHSs + RACFs etc.].
National Medical Stockpile (NMS)	Coordinate development of policy, in consultation with states/territories regarding the inventory and deployment of the NMS (including conduct of any modelling/ research required to inform decisions). Provide guidance on how the NMS can be accessed. Consider measures to strengthen coordination of supply chains.	Provide input into the development of policy regarding the inventory and deployment of the NMS. Develop a jurisdictional NMS distribution plan.	Provide advice/clear policy regarding the inventory and deployment of the NMS [AHPPC, CDNA, PHLN]. Develop policy on use of pre- and post-exposure prophylaxis for Healthcare Workers [CDNA].	Provide input on needs related to stockpile and the deployment of the stockpile. [e.g. GPs through GP Roundtable, ACCCHSs, pharmacists, hospitals through S/T HD].

Preparedness roles:	The Australian Government role is to:	The State and Territory Governments role is to:	The joint role of Australian Government and State and Territory Governments is to:	The role of other health sector parties is to:
Antivirals	Consider the effectiveness of antivirals and inform policy on use accordingly.	Consider any information provided on the effectiveness of antivirals and inform policy on use accordingly.	Comment on the quality of evidence obtained concerning the effectiveness of antivirals [CDNA].	Disseminate in accordance with policy. Support dissemination of national advice on when to use antivirals and who should receive them [hospitals + peak bodies, such as GP organisations, NACCGO, ACEM, RANZCOG, RACGP].
Laboratory				
Collaboration	Support a collaborative public health laboratory network. Maintain communication with private health laboratory networks [PHLN].	Maintain a public health laboratory network. Maintain communication with private health laboratory networks.	Provide leadership and consultation in aspects of public health microbiology and communicable disease control [PHLN].	Provide feedback on service provision.
Capacity	Build national laboratory capacity through the supply of laboratory equipment, tests and reagents, to meet identified gaps in capacity.	Build jurisdictional laboratory capacity through the supply of laboratory equipment, tests and reagents, to meet identified gaps in capacity.	Provide strategic advice to the AHPPC to identify gaps and needs in laboratory capacity [PHLN].	Support early detection and laboratory analysis of influenza viruses [labs, NICs, WHOCC].
Regulation	Register new pharmaceuticals and vaccines as approved for use in Australia, following assessment of quality, safety and efficacy [TGA].			

Preparedness roles:	The Australian Government role is to:	The State and Territory Governments role is to:	The joint role of Australian Government and State and Territory Governments is to:	The role of other health sector parties is to:
Public communication	Establish communications protocols for emergencies.	Contribute to establishment of communication protocols for emergencies. Ensure effective communication systems and processes are in place.	Endorse communication protocols for emergencies [AHPPC].	<p>Contribute to public communication delivery.</p> <p>Support communications to CALD communities.</p> <p>Coordinate information delivery for the ACCHS sector and input feedback to decision making processes [NACCHO].</p> <p>Establish capacity for sharing information within EDs and local medical officer waiting rooms (paper and television screen savers) [hosp + GPs + PHN]</p>
Institutional Setting				
Overall	Establish standards to promote the safety and security of people in institutional settings.	Establish systems to promote the safety and security of people in institutional settings.	Consider and endorse standards to promote the safety and security of people in institutional settings [CDNA, AHPPC].	Develop emergency plans for individual institutional settings.

Preparedness roles:	The Australian Government role is to:	The State and Territory Governments role is to:	The joint role of Australian Government and State and Territory Governments is to:	The role of other health sector parties is to:
Residential Aged Care Facilities	Manage a system to promote the safety and security of people in aged care settings.	Establish systems to promote the safety and security of people in aged care settings. Respond to outbreaks of influenza with RACF (Public Health Units).	Develop policy for Public Health Unit response to RACF influenza outbreaks and develop guidance for RACFs for seasonal influenza outbreak prevention response [CDNA].	Meet Residential Aged Care Accreditation standards. Implement national guidance for RACF for seasonal influenza outbreak prevention and response. Develop and/participate in prevention and treatment response measures [Medication advisory committees in RACFs]. Develop emergency plans for Aboriginal aged care settings [NACCHO to support]. Liaise with S/T public health authorities.
International Borders				
Border control services	Establish arrangements to provide services by Australian Government border agencies and jurisdictional health departments.	Participate in arrangements for the provision of services to support border control measures.	Make recommendations for use of border security measures. Advise on efficient models to support border control measures [CHBOs].	
Legislative support	Develop and maintain legislation to support implementation of measures at Australia's international borders.	Apply powers of appointed human biosecurity officials as required.	Consider and advise on legislative changes and interaction with S/T public health legislation [CHBOs and AHPPC].	

Preparedness roles:	The Australian Government role is to:	The State and Territory Governments role is to:	The joint role of Australian Government and State and Territory Governments is to:	The role of other health sector parties is to:
IHR	Maintain IHR core capacities. Maintain National Focal Point (NFP) under IHR.	Maintain IHR core capacities. Maintain communications with NFP according to IHR reporting requirements and quarantine service provision agreements.	Contribute to IHR core capacities.	Contribute to IHR core capacities.
Australian Medical Assistance Team (AUSMAT)	Maintain a system to manage activation and deployment of AUSMAT for international support.	Maintain a jurisdictional register of responders (for AUSMAT).		Establish and maintain a list of GPs, nurses, paramedics and allied health staff available to support services in areas overwhelmed by the emergency through short term relief [relevant professional bodies, e.g. RACGP Disaster Management Network].
International obligations	Regional support to capacity building (planning) and to response [coordinated by DFAT].	Contribute expertise to regional programs.	Technical advice from a range of national health sector bodies may be shared regionally (on request).	Contribute expertise to regional programs.

Table 18: Roles and responsibilities of the Australian Government, State and Territory Governments and the health sector during the Standby stage.

Standby Roles:	The Australian Government role is to:	The State and Territory Governments role is to:	The joint role of Australian Government and State and Territory Governments is to:	The role of other health sector parties is to:
Overarching role				
<p>Prepare national resources that may be needed to manage the pandemic.</p> <p>Coordinate information gathering and sharing about the virus and the emerging pandemic.</p> <p>Manage international obligations and borders.</p>	<p>Prepare jurisdictional resources that may be needed to manage the pandemic.</p> <p>Coordinate communication at state and local levels according to national guidance.</p> <p>Support management of international borders by providing disease control expertise and health care services to ill travellers.</p>	<p>Share information on resource availability [AHPPC].</p> <p>Prepare guidance on case and contact management; chemoprophylaxis and education; vaccination; quarantine/isolation; risk assessment; infection control and use of antivirals [CDNA].</p> <p>Prepare advice where relevant on interventions outside the health sector, such as social distancing measures [CDNA/AHPPC].</p>	<p>Prepare organisational personnel and resources for changes in demand and service use that may be required to manage the pandemic.</p> <p>Raise awareness of communication channels [peak bodies].</p>	

Standby Roles:	The Australian Government role is to:	The State and Territory Governments role is to:	The joint role of Australian Government and State and Territory Governments is to:	The role of other health sector parties is to:
Surveillance				
Domestic surveillance	Coordinate collection of jurisdictional data to monitor for the first cases of the new virus.	Collect data to monitor for the first cases of the new virus. Share information with the Australian Government (specifics of data sharing arrangements negotiated in Surveillance Plan). Share jurisdictional data with State/Territory Minister and state and local level stakeholders.	Interpret surveillance data and provide expert advice on status of pandemic [CDNA]. Develop and update surveillance case definitions. Case definitions will include a probable case, a confirmed case and a contact [CDNA]. Provide other guidance, may include duration of incubation and infectious period, and estimates of infectiousness (R) [CDNA]. Establish testing priorities (who should be tested) [CDNA/PHLN]	To support detection of the first cases, provide input into <ul style="list-style-type: none"> state/territory surveillance systems [GPs + hospitals] National Notifiable Disease Surveillance System. [GPs + hospitals + laboratories] To support detection of the first cases, provide input into <ul style="list-style-type: none"> sentinel systems (e.g. influenza hospitalisations; testing of influenza-like-illness [participating GPs + hospitals] identification of outbreaks in RACFs [RACFs] and other institutions including schools and childcare centres. Coordinate communication around case incidence and detection across the ACCHS sector [NACCHO].

Standby Roles:	The Australian Government role is to:	The State and Territory Governments role is to:	The joint role of Australian Government and State and Territory Governments is to:	The role of other health sector parties is to:
International Surveillance				
At-risk groups	Collate and analyse international data to show emerging trends. Share information with the offices of the Minister for Health, Minister for Mental Health and Ageing, decision makers, WHOCC, public health professionals and the public.	Share international data with relevant state and territory government agencies and other health sector parties	Consider international data and advise on implications for Australia [CDNA].	Share data with healthcare members through representative organisations.
	Analyse implications of international surveillance data in terms of at-risk groups to inform national level decision making. Reflect the needs of at-risk groups in national level decision making.	Reflect the needs of at-risk groups in jurisdictional level decision making.	Identify (confirm) at-risk groups [CDNA, possibly with additional expertise]. Establish a national case definition for an individual at risk of complications. Define the minimum data set so agreed parameters are collected across jurisdictions (taking into account jurisdictional capacity). Work in conjunction with other experts to provide tailored guidance for at-risk groups (e.g. work with Health Senior Clinical Advisor and Health Quality and Monitoring Branch to develop guidelines for RACFs and childcare centre operators). [CDNA].	Raise awareness of anticipated at-risk groups and their needs [peak bodies].

Standby Roles:	The Australian Government role is to:	The State and Territory Governments role is to:	The joint role of Australian Government and State and Territory Governments is to:	The role of other health sector parties is to:
Infection Control				
Infection control standards	Confirm application of standard infection control standards, or advise of any recommended modifications.	Confirm application of standard infection control strategies, or advise of any recommended modifications.	Tailor Infection Control Guidelines to the risks relevant to this virus (if required) [CDNA with the support of additional expertise].	Confirm application of standard infection control standards, or advise of any recommended modifications [peak bodies].
PPE	Prepare PPE in stockpiles for deployment (if held).	Prepared to distribute PPE if made available from stockpiles. Prepared to support appropriate use of PPE as part of coordinated response.		Prepare stocks of PPE for use, revise usage practices. Provide information and support education regarding supply of articles such as PPE and hand sanitiser [MTAA].
Health workforce	Ensure health workforce is aware of status of the pandemic, proposed approaches and any public health activities being undertaken during this stage.	Ensure health workforce is aware of status of the pandemic, proposed approaches and any public health activities being undertaken during this stage.		Ensure health workforce is aware of status of the pandemic, proposed approaches and any public health activities being undertaken during this stage [peak bodies].

Standby

Standby Roles:	The Australian Government role is to:	The State and Territory Governments role is to:	The joint role of Australian Government and State and Territory Governments is to:	The role of other health sector parties is to:
Public Health Measures				
	Coordinate and facilitate preparation of nationally consistent and agreed countermeasures to protect public health.	Prepare jurisdictional response activities such as influenza services, assessment & treatment centres, and other wider community interventions.	Advise which public health measures should be implemented at this stage [CDNA/ PHLN/ Health]. Share information on resource availability. Consider, select and organise implementation of public health measures appropriate to this stage [AHPPC].	Prepare to participate in public health measures to manage the pandemic, while maintaining business continuity for essential services. Prepare arrangements for triaging [primary care]. Prepare arrangements for cohorting of patients [e.g. GPs (if appropriate), hospitals]. Prepare arrangements for reducing non-urgent work.
Immunisation				
Pandemic vaccine program	Develop pandemic specific immunisation program delivery strategy. Ensure needs of at-risk groups are incorporated. Consider whether to activate existing vaccine supply. Liaise with suppliers to ensure readiness to commence manufacture. Pre-deploy vaccination equipment (if appropriate).	Provide input into development of pandemic specific immunisation program. Receive and manage distribution of vaccination equipment.	Advise on development of pandemic specific immunisation program, including priority groups. [ATAGI/ NIC].	

Standby Roles:	The Australian Government role is to:	The State and Territory Governments role is to:	The joint role of Australian Government and State and Territory Governments is to:	The role of other health sector parties is to:
Candidate vaccines			Provide advice on appropriateness of candidate vaccines to current pandemic, and appropriate target groups. [ATAGI + relevant experts]. Decide whether to commence candidate vaccine and which groups will be targeted [AHPPC].	Isolate potential pandemic vaccine viruses [WHOCC].
Medical Countermeasures Stockpiles	Coordinate pre-positioning of NMS items.	Receive and manage pre-positioned stockpile items.	Consider need to pre-position stockpile items early in response [CDNA/AHPPC].	Businesses/organisations to consider protective needs of staff (PPE, management practices).
Antivirals	Monitor international sources for information concerning antiviral resistance.		Monitor international sources for information concerning antiviral resistance [CDNA].	Monitor antiviral resistance [WHOCC. NIC].

Standby Roles:	The Australian Government role is to:	The State and Territory Governments role is to:	The joint role of Australian Government and State and Territory Governments is to:	The role of other health sector parties is to:
Laboratory				
Case definition			<p>Develop and maintain the laboratory case definition (LCD). The LCD will provide definitive and suggestive criteria that must be met to report a laboratory confirmed diagnosis.</p> <p>The LCD is also likely to provide guidance on:</p> <ul style="list-style-type: none"> the type of clinical specimen required and sample collection guidance; detection methodologies, such as culture, molecular methods such as polymerase chain reaction, molecular characterisation (typing and sub-typing methods) and serology; quality assurance considerations. <p>The LCD will be developed by PHLN and is likely to be included in CDNA case definition information.</p>	Educate members on the laboratory case definition and support its application [Peak bodies].

Standby Roles:	The Australian Government role is to:	The State and Territory Governments role is to:	The joint role of Australian Government and State and Territory Governments is to:	The role of other health sector parties is to:
Testing protocols	Support the needs of laboratories to develop pandemic PCR and serological testing	Develop and validate pandemic virus PCR tests.	<p>Acquire relevant isolates (most likely through WHOCC) and sequencing data for test development; distribute this information. (If well-established elsewhere, may acquire test itself) [PHLN].</p> <p>Share isolates with WHOCC for characterisation [PHLN].</p> <p>Develop laboratory testing protocols.</p> <p>Determine triggers for authorising laboratory testing in the early phase; transferring testing from reference laboratories to general laboratories; restricting testing to clinically relevant patients only i.e. when it is no longer necessary to test all suspect cases.</p> <p>Determine point during pandemic at which it is no longer necessary to test all suspect cases and inform stakeholders. Advise on likely turnaround times for testing [PHLN].</p>	<p>Obtain representative viruses from other countries and/or Australia [WHOCC].</p> <p>Share testing technologies [WHOCC, NICs, labs].</p>

Standby

Standby Roles:	The Australian Government role is to:	The State and Territory Governments role is to:	The joint role of Australian Government and State and Territory Governments is to:	The role of other health sector parties is to:
Public Communication				
Consistent messaging	Convey high level messaging to general public [Chief Medical Officer]. Provide advice on high risk destinations. Prepare messaging appropriate for special groups (such as at-risk groups, remote communities, CALD).	Convey high level messaging to general public related to jurisdiction specific measures [Chief Health Officer]. Prepare messaging appropriate for special groups (such as at-risk groups, remote communities, CALD).	Share information and approaches to coordinate a consistent public message (such as hygiene, PPE) [AHPPC/ CDNA]. Advise on messaging appropriate for special groups (such as at-risk groups, remote communities, CALD).	Support provision of quality health information. Communicate about anticipated risks and encourage behaviours which contribute positively to managing the risk of infection, such as respiratory etiquette, hand washing, mask wearing and vaccination [public and mental health experts + RANZCOG]. Inform general public of at-risk destinations if consulted re travel [GPs + travel medicine practitioners].
Media engagement	Liaise with S/T re media.	Liaise with Australian Government re media.	Keep the public and the media informed of emerging information about the pandemic, providing consistent and coordinated media and public responses [NHEMRN].	
Institutional settings	Support preparations in institutional settings to manage the pandemic.	Support preparations in institutional settings to manage the pandemic.	Support preparations in institutional settings to manage the pandemic.	Prepare to commence activities required to manage the pandemic.

Standby Roles:	The Australian Government role is to:	The State and Territory Governments role is to:	The joint role of Australian Government and State and Territory Governments is to:	The role of other health sector parties is to:
International borders				
International borders	<p>If recommended, coordinate and implement border agency heightened activities [Health]</p> <ul style="list-style-type: none"> • identification • awareness raising. <p>Liaise with airports, airlines, seaports and shipping agencies.</p> <p>If recommended, coordinate and implement border agency heightened activities [Health]</p> <ul style="list-style-type: none"> • identification • awareness raising. 	<p>Contribute expertise to implementation of border activities [e.g. human biosecurity officials].</p> <p>Support implementation of border measures by providing health care to ill travellers identified by border measures.</p>	<p>Determine the purpose of border measures under current circumstances and types of border measures to be implemented [AHPPC with advice from CHBOs].</p> <p>Advise on border related disease management strategies such as allowance of on-travel of identified ill travellers [CHBOs].</p>	<p>Work with state and territory governments to manage and treat ill travellers identified at the border.</p>
Legislative support	<p>Undertake any legislative processes required to support implementation or modification of border measures.</p>	<p>Undertake any state based legislative processes required to support implementation of border measures.</p>	<p>Consider and advise on legislative changes and interaction with S/T public health legislations [CHBOs and Chief Health Officers].</p>	
International obligations	<p>Communicate with WHO to obtain details regarding disease.</p>	<p>Gather information through international relationships at state and territory level.</p>		

Table 19: Roles and responsibilities of the Australian Government, State and Territory Governments and the health sector during the Preparedness stage.

Initial and Targeted Action Roles	The Australian Government role is to:	The State and Territory Governments role is to:	The joint role of Australian Government and State and Territory Governments is to:	The role of other health sector parties is to:
Overarching role				
Tailoring of measures	Support coordination and communication when jurisdictional capacity is overwhelmed OR when an incident is multi-jurisdictional.	Undertake primary responsibility for the management of the public health response in jurisdictions, including management of cases; clinical care; contact management and public health measures. Request assistance if jurisdictional capacity is overwhelmed. Coordinate response and communication at state and local levels according to national guidance.	Share information on resource availability and coordinate access to resources to maximise the effectiveness of the response [AHPPC]. Provide guidance on case and contact management; chemoprophylaxis and education; vaccination; quarantine/isolation; risk assessment; infection control and use of antivirals [CDNA]. Provide advice where relevant on interventions outside the health sector, such as social distancing measures.	Maintain business continuity for essential services AND/OR deliver pandemic measures and distribute information. Provide input into decision making fora. Triage and coordinate care for patients between other service providers [GPs, Emergency Departments (EDs), ACCHS, pharmacists, mental health workers etc.] Help to ensure communication is in a format that is useful and easily understood by their part of the health sector [peak bodies]. Advise on the timing and impact of reducing enhanced clinical influenza services.

Initial and Targeted Action Roles	The Australian Government role is to:	The State and Territory Governments role is to:	The joint role of Australian Government and State and Territory Governments is to:	The role of other health sector parties is to:
Tailoring of measures (cont.)	Adjust any measures taken to take into account changes in surveillance information, equity and resource issues. Mitigate inequities where possible through planning processes.	Adjust any measures taken to take into account changes in surveillance information, equity and resource issues. Mitigate inequities where possible through planning processes.	Adjust any guidance given to taken to take into account changes in surveillance information, equity and resource issues.	Adjust any measures taken to take into account changes in guidance provided, equity and resource issues.
Surveillance				
International Surveillance	Collate and analyse international data to show emerging trends. Share information with the offices of the Minister for Health, decision makers, WHOCC, public health professionals and the public.	Share international data with relevant state and territory government agencies and other health sector parties.	Consider international data and advise on implications for Australia [CDNA].	Share data with healthcare members through representative organisations. Confirm initial cases for WHO [WHOCC].

Initial and Targeted Action Roles	The Australian Government role is to:	The State and Territory Governments role is to:	The joint role of Australian Government and State and Territory Governments is to:	The role of other health sector parties is to:
<p>Domestic Surveillance:</p>	<p>Collate and analyse jurisdictional data to report on emerging national trends. Share information with the offices of the Minister for Health, state and territory health departments, decision makers, clinicians, WHOCC, public health professionals and the public.</p>	<p>Collect data to inform the jurisdictional public health response. Share information with the Australian Government (specifics of data sharing arrangements negotiated in Surveillance Plan). Share jurisdictional data with State/Territory Minister and state and local level stakeholders.</p>	<p>Interpret surveillance data and provide expert advice on status of pandemic [CDNA]. Review testing priorities (who should be tested) [CDNA/PHLN].</p>	<p>Provide input into</p> <ul style="list-style-type: none"> state/territory surveillance systems [GPs + hospitals] National Notifiable Disease Surveillance System. [GPs + hospitals + laboratories] sentinel systems (e.g. influenza hospitalisations; testing of influenza-like-illness [participating GPs + hospitals]) identification of outbreaks in RACFs [RACFs] and other institutions including schools and childcare centres. Coordinate communication around case incidence and detection across the ACCHS sector [NACCHO]. <p>Monitor antigenicity, antiviral resistance and other viral characteristics [WHOCC].</p>

Initial and Targeted Action Roles	The Australian Government role is to:	The State and Territory Governments role is to:	The joint role of Australian Government and State and Territory Governments is to:	The role of other health sector parties is to:
At-risk groups	Monitor and analyse surveillance data in terms of at-risk groups to inform national level decision making. Reflect the needs of at-risk groups in national level decision making.	Monitor and analyse surveillance data in terms of at-risk groups to inform jurisdictional level decision making. Reflect the needs of at-risk groups in jurisdictional level decision making.	Establish/advise on a national case definition for an individual at risk of complications. Define the minimum data set so agreed parameters are collected across jurisdictions (taking into account jurisdictional capacity). Work in conjunction with other experts to provide tailored guidance for at-risk groups (e.g. work with Health Senior Clinical Advisor and Health Quality and Monitoring Branch to develop guidelines for RACFs)[CDNA].	Identify, monitor and support the needs of at-risk groups [GPs + ACCHSs + RACF + RANZCOG + hospitals + community nurses + ambulance organisations etc.]. Support communication to CALD communities.

Initial and Targeted Action

Initial and Targeted Action Roles	The Australian Government role is to:	The State and Territory Governments role is to:	The joint role of Australian Government and State and Territory Governments is to:	The role of other health sector parties is to:
Escalation to national response	Activate and manage National Incident Room.	Report issues to the NIR which might foreshadow the requirement for a coordinated response. Escalate measures according to risk assessment appropriate to individual jurisdiction.	Consider clinical, laboratory and epidemiological surveillance, resource and political information to determine whether a national response is required (escalate plan) [AHPPC]. Advise on thresholds for escalation [CDNA/PHLN].	Provide input into GP Roundtable. Provide input into clinical expert groups. Provide input through RACGP's endorsed Disaster Management Network. Provide input through Public Health Medical Officers Network. Representative aged care providers/peak bodies to come together to provide input. Provide input into the Clinical Stakeholders Forum.

Initial and Targeted Action Roles	The Australian Government role is to:	The State and Territory Governments role is to:	The joint role of Australian Government and State and Territory Governments is to:	The role of other health sector parties is to:
Infection Control				
Infection control standards	Maintain appropriate infection control standards.	Maintain appropriate infection control standards.		Maintain appropriate infection control standards.
PPE	Coordinate allocation of PPE within or between jurisdictions if overwhelmed.	Distribute PPE made available from stockpiles. Support appropriate use of PPE as part of coordinated response. Advise AHPPC of PPE needs if stocks threatened.	Provide guidance on PPE use to coordinate a consistent approach. Provide advice to organisations and the public re infection control appropriate to the virus [CDNA].	Maintain respiratory hygiene products appropriate for infection control [e.g. GPs + nurses + hosp+ ambulance/paramedic services + ACCCHSs + RACF]. Businesses/organisations to consider protective needs of staff. (PPE, management practices) Provide information and support education regarding supply of articles such as PPE and hand sanitiser [MTAA]. Advise on concerns regarding use of nebulisers and non-invasive ventilation unless in negative pressure rooms [ACEM].

Initial and Targeted Action

Initial and Targeted Action Roles	The Australian Government role is to:	The State and Territory Governments role is to:	The joint role of Australian Government and State and Territory Governments is to:	The role of other health sector parties is to:
Point of care testing	Consider Medical Benefits Scheme funding of Point of Care tests.	Undertake point of care testing. Coordinate data management & reporting.	Develop guidelines for use and interpretation of results for point of care testing [CDNA and PHLN].	Support Point of Care testing, if recommended for flow and patient management.
Health workforce				
GPs	<p>Seek input from GPs through GP Roundtable and RACGP Disaster Management Network. Ensure input is shared with S/T health departments.</p> <p>Provide GPs with information and seek their input through PHN.</p>	Provide GPs with information and seek their input through the RACGP Disaster Management Network. Share input received with Australian Government.	<p>Support RACFs [GPs, PHN]</p> <p>Support health practitioners as spokespeople by ensuring communication of relevant information [through GP Roundtable, RACGP Disaster Management Network and PHN].</p>	<p>Provide input into GP Roundtable [GPs].</p> <p>Coordinate input from ACCHSs [NACCHO].</p> <p>Disseminate information from consultative fora to general public, as appropriate.</p> <p>Communicate access and demand circumstances in EDs (EDs + ACEM).</p>

Initial and Targeted Action Roles	The Australian Government role is to:	The State and Territory Governments role is to:	The joint role of Australian Government and State and Territory Governments is to:	The role of other health sector parties is to:
Primary Health Networks	Coordinate linkage of PHN into communication strategies.	Communicate with PHN. Collaborate with PHN to fill identified service provision gaps.	Support health practitioners as spokespeople by ensuring communication of relevant information [through GP Roundtable, RACGP Disaster Management Network and PHN].	<p>PHN to support data collection and identification of gaps in services, additional resource requirements and vulnerabilities in patient populations relevant for their region [PHN to work together with local ACCHSs and other key groups].</p> <p>PHN to have dedicated staff and call line to support health practitioners including resource coordination.</p> <p>PHN to liaise with local hospitals/EDs re demand, access and expectations.</p>
Hospitals	Consider widening prescription rights for nurses during the emergency, to include antivirals and other key medications.	Establish and maintain public hospital system. Support hospitals in coping with increased admissions, increased acuity and access block. Consider opening more beds, cancellation of non-essential procedures. Support hospital systems to maintain essential services.		<p>Resuscitate and treat the sickest patients. Disseminate information to the general public [hospitals].</p> <p>Implement triage, coordinate between services, manage patients and after-hours care [hospitals — EDs particularly central].</p>

Initial and Targeted Action

Initial and Targeted Action Roles	The Australian Government role is to:	The State and Territory Governments role is to:	The joint role of Australian Government and State and Territory Governments is to:	The role of other health sector parties is to:
Other health practitioners	<p>Seek input through professional associations.</p> <p>Liaison with RACFs.</p> <p>Consider widening prescription rights for nurses during the emergency, to include antivirals and other key medications.</p>	<p>Liaison with healthcare providers to provide information and seek their input on trends and the effectiveness of approaches.</p>	<p>Support health practitioners as spokespeople by ensuring communication of relevant information [through relevant professional associations].</p>	<p>Provide input on the effectiveness of measures and emerging issues through professional associations.</p> <p>Disseminate information to general public. Community nurses, pharmacists and pharmacists will have a key role in information distribution.</p>
Public Health Measures				
Public Health Countermeasures	<p>Auspice the coordination and facilitation of nationally consistent and agreed countermeasures to protect public health.</p>	<p>Coordinate jurisdictional response activities such as influenza services, assessment & treatment centres, and other wider community interventions.</p>	<p>Share information on resource availability and coordinate access to resources to maximise the effectiveness of the response [AHPPC].</p>	<p>Deliver pandemic measures as part of coordinated response and/or maintain business continuity for essential services.</p> <p>Telephone support of patients who choose to or are advised to undertake home quarantine, if this measure is recommended.</p>

Initial and Targeted Action Roles	The Australian Government role is to:	The State and Territory Governments role is to:	The joint role of Australian Government and State and Territory Governments is to:	The role of other health sector parties is to:
Immunisation				
Pandemic vaccine program	Develop pandemic specific immunisation program. Ensure needs of at-risk groups are incorporated.	Coordinate pandemic immunisation program.	Coordinate implementation of state/territory immunisation programs [NIC].	Provide immunisation services. Identify individuals at risk that would be most likely to benefit from immunisations [GPs, health care nurses, hospitals, ACCHSs, pharmacies may also be used to provide immunisation services.]
Medical Countermeasures Stockpiles				
Deployment	Coordinate operational management of the NMS when activated (through NIR). Respond to national deficits, where possible.	Coordinate distribution of stockpile materials and support use by public and health professionals (NMS or jurisdictional).	Consider whether agreed triggers for deployment are present. Determine priority groups if there are areas of short supply [AHPPPC].	Support distribution and use of stockpile items (particularly antivirals) potentially through PHN, hospitals, pharmacies, home nursing services (to facilitate easy acquisition and decrease time spent trying to obtain supplies.) Provide respiratory hygiene products and equipment to the general public for infection control [pharmacists].
Maintaining stockpiles	Liaise with other Australian Government departments, such as Department of Finance or Department of Foreign Affairs and Trade (for needs of embassy staff) regarding the NMS.	Share information with other jurisdictional government and health sector parties. Liaise with clinical sector.	Consider and agree on prioritisation of stockpile if required [AHPPPC].	Coordinate to identify a clear message on needs and provide this input through professional associations [e.g. RACGP, NACCHO, ACEM, ambulance services, RACF].

Initial and Targeted Action

Initial and Targeted Action Roles	The Australian Government role is to:	The State and Territory Governments role is to:	The joint role of Australian Government and State and Territory Governments is to:	The role of other health sector parties is to:
Antivirals	Use national and international antiviral resistance patterns, disease severity data and data on at-risk populations to inform policy on NMS.	Coordinate administration of antivirals. Use national guidelines and health service capacity assessment to inform policy on jurisdictional stockpile items.	Facilitate antiviral resistance testing [PHLN]. Conduct surveillance of antiviral adverse event monitoring [TGA/CDNA]. Provide advice concerning the use and distribution of antivirals [CDNA/ AHPPC]. Provide advice concerning the use of antivirals in infants and children, pregnant and lactating women [CDNA/ AHPPC].	Prescribe and deliver antivirals according to NMS and state policy. Conduct resistance tests [WHOCC, NICs]. Provide input into discussions concerning effectiveness, side-effects and dissemination of antivirals [GPs, hospitals, pharmacists, WHOCC]. Use existing trial networks/ academic collaborations to assemble and analyse evidence concerning current and best practice [academia].

Initial and Targeted Action Roles	The Australian Government role is to:	The State and Territory Governments role is to:	The joint role of Australian Government and State and Territory Governments is to:	The role of other health sector parties is to:
Laboratory				
Testing	<p>Support the needs of a public health laboratory network.</p> <p>Promote higher quality testing by making available (or restricting) subsidisation under the Medical Benefits Scheme /Pharmaceutical Benefits Scheme</p>	<p>Undertake testing, surge [public health labs].</p> <p>Implement testing protocol developed by PHLN.</p>	<p>Share testing technologies, including with private laboratories [PHLN]</p>	<p>Undertake pandemic testing, surge to increase testing [labs]</p> <p>Provide surveillance information to Public Health Units including denominator data on testing [labs]</p> <p>Implement testing protocols developed by PHLN [GPs + hospitals + ACCHSs].</p> <p>Support case management and surveillance needs.</p> <p>Support dissemination of direction on pathology testing and consistent messages about surveillance by front-line health workers [e.g. GP organisations, NACCHO, ACEM, RACP].</p> <p>Develop and test POC testing to facilitate hospital flow and patient management, where appropriate.</p> <p>Provide reference material to public health laboratories to aid the development of diagnostic assays [WHOCC].</p>

Initial and Targeted Action

Initial and Targeted Action Roles	The Australian Government role is to:	The State and Territory Governments role is to:	The joint role of Australian Government and State and Territory Governments is to:	The role of other health sector parties is to:
Laboratory staff use of antivirals		Distribute antivirals for use as per guidelines developed by PHLN	Develop and maintain guidance for pathology and research staff regarding antiviral prophylaxis [PHLN].	Distribute guidance to pathology and research, hospital staff and GPs (and other relevant health sector parties) [peak bodies].
Public Communication				
Consistent messaging	Convey high level messaging to general public [Chief Medical Officer].	Convey high level messaging to general public related to jurisdiction specific measures [Chief Health Officer].	Share information and approaches to coordinate a consistent public message (such as hygiene, PPE) [AHPPC/ CDNA].	Support provision of quality health information. Communicate about risks and encourage behaviours which contribute positively to managing the risk of infection, such as mask wearing or vaccination [public and mental health experts]. Inform general public of high risk destinations if consulted re travel [GPs + travel medicine practitioners].
Media engagement	Liaise with S/T re media.	Liaise with Australian Government re media.	Keep the public and the media informed during national health emergencies by providing consistent and coordinated media and public responses [NHEMRN].	

Initial and Targeted Action Roles	The Australian Government role is to:	The State and Territory Governments role is to:	The joint role of Australian Government and State and Territory Governments is to:	The role of other health sector parties is to:
Institutional Settings				
Overall	Work with state and territory governments to monitor the impact of the pandemic in institutional settings.	Investigate and support outbreak management. Disseminate relevant information.	Consider the need for additional action specific to institutional settings. Identify the appropriate bodies to undertake provision of this action/advice [AHPPC on advice from CDNA, jurisdictions, the GP Roundtable].	Work with state and territory governments and healthcare providers concerning outbreak management [as relevant].
Residential Aged Care Facilities	Work with approved providers and regulatory structures of aged care to disseminate relevant tailored information. Liaise with S/T HD units with responsibilities related to the pandemic.	Investigate and support outbreak management. Disseminate relevant information.	Develop and maintain guidance concerning management of influenza outbreaks in RACFs [CDNA].	Provide additional support relevant to Influenza-like-illness. Distribute information. Liaise with S/T HD public health units, including reporting respiratory outbreaks and risks to residents from outbreaks. Consider advice and adapt practices accordingly [RACFs]. Develop and/participate in prevention and treatment Response measures [Medication advisory committees in RACFs]. Consider use of POC testing for early diagnosis, treatment and cohorting.

Initial and Targeted Action

Initial and Targeted Action Roles	The Australian Government role is to:	The State and Territory Governments role is to:	The joint role of Australian Government and State and Territory Governments is to:	The role of other health sector parties is to:
Educational facilities	Liaise with Australian Government education authorities.	Investigate and support outbreak management. Disseminate relevant information. Liaise with state/ territory government education authorities.	Provide advice through WoG processes on social distancing measures relevant to the school environment [CDNA, with other expertise as required].	Provide education on request [GPs, school nurses].
Military facilities	Investigate and support outbreak management. Disseminate relevant information.	Disseminate relevant information. Support outbreak investigation and management.		Liaise with Australian Government.
Correctional facilities		Investigate and support outbreak management. Disseminate relevant information.	Liaise with justice bodies on relevant best-practice guidance with respect to control measures [CDNA].	Use knowledge of clients to identify individuals at risk of complications, support surveillance [e.g. GPs, NACCHO].
International borders	<p>If recommended, coordinate and implement border agency heightened activities [Health]</p> <ul style="list-style-type: none"> • identification • awareness raising. <p>Liaise with airports, airlines, seaports and shipping agencies.</p> <p>Provide officers to participate in implementation of border measures.</p>	<p>Contribute expertise to implementation of border activities [e.g. human biosecurity officials].</p> <p>Support implementation of border measures by providing health care to ill travellers identified by border measures.</p>	<p>Determine the purpose of border measures under current circumstances and types of border measures to be implemented [AHPPC with advice from CHBOs]. Advise on border related disease management strategies such as allowance of on-travel of identified ill travellers [CHBOs].</p>	<p>Work with state and territory governments to manage and treat ill travellers identified at the border.</p>

Initial and Targeted Action Roles	The Australian Government role is to:	The State and Territory Governments role is to:	The joint role of Australian Government and State and Territory Governments is to:	The role of other health sector parties is to:
International obligations				
International Health Regulations (IHR)	Undertake IHR reporting requirements. Maintain core capacities.	Report IHR issues within jurisdictions to Australian Government. Contribute to provision of core capacities.	Contribute to provision of core capacities.	Contribute to provision of core capacities.
International liaison	Communicate with WHO to obtain details regarding disease.	Gather information through international relationships at state and territory level.		
Australian Medical Assistance Team (AUSMAT)	Coordinate provision of AUSMATs in response to a request for international assistance.	Contribute expertise to the AUSMAT.	Consider requests for health assistance (domestic or international) and identify the appropriate mechanism for providing the response [AHPPC].	Contribute expertise to AUSMAT.
Exit screening	Manage any requests for exit screening from WHO or other state parties.	Manage people identified through exit screening by integrating them into state and territory health systems.	Develop and maintain a protocol outlining how people identified under exit screening should be managed. This will include indications regarding funding. Public health specifics developed by CDNA, wider policy implications decided by AHPPC.	Support management of people identified in exit screening.

(Information about products, such as surveillance case definitions is indicative only.)

Table 20: Roles and responsibilities of the Australian Government, State and Territory Governments and the health sector during the Standdown stage

Standdown roles	The Australian Government role is to:	The State and Territory Governments role is to:	The joint role of Australian Government and State and Territory Governments is to:	The role of other health sector parties is to:
Standdown of activities	<p>Coordinate the development and implementation of an exit strategy to stand down enhanced measures.</p> <p>Consult across the Australian Government concerning scaling back of measures.</p> <p>Manage transition of processes into seasonal arrangements.</p>	<p>Implement exit strategy relevant to measures taken on by state and territory government officers and agencies.</p> <p>Consult across jurisdictional government concerning scaling back of measures.</p> <p>Manage transition of services and processes into seasonal arrangements.</p>	<p>Determine when to cease or alter enhanced measures [AHPPC].</p> <p>Provide advice regarding stand-down of measures [CDNA].</p> <p>Advise on appropriate messaging for responders and public concerning scaling down of measures [AHPPC/ NHEMRN].</p>	<p>Explain reasons for scaling back and how this will happen to practitioners [peak bodies].</p> <p>Explain reasons for scaling back and how this will happen to public.</p> <p>Support implementation of exit strategy.</p> <p>Manage transition of services into normal arrangements (if altered).</p>
Evaluation	Evaluate Australian Government pandemic processes. Implement changes as appropriate.	Evaluate jurisdictional pandemic processes. Implement changes as appropriate.	Evaluate committee and governance processes. Implement changes as appropriate.	Evaluate organisation/ practice/business processes. Implement changes as appropriate.

www.health.gov.au

All information in this publication is correct as at August 2019